

CHAPTER III

AIR BLAST PHENOMENA IN AIR AND SURFACE BURSTS

CHARACTERISTICS OF THE BLAST WAVE IN AIR

DEVELOPMENT OF THE BLAST WAVE

3.01 Most of the material damage caused by a nuclear explosion at the surface or at a low or moderate altitude in the air is due—directly or indirectly—to the shock (or blast) wave which accompanies the explosion. Many structures will suffer some damage from air blast when the overpressure in the blast wave, i.e., the excess over the atmospheric pressure (14.7 pounds per square inch at standard sea level conditions), is about one-half pound per square inch or more. The distance to which this overpressure level will extend depends primarily on the energy yield (§ 1.20) of the explosion, and on the height of the burst. It is consequently desirable to consider in some detail the phenomena associated with the passage of a blast wave through the air.

3.02 A difference in the air pressure acting on separate surfaces of a structure produces a force on the structure. In considering the destructive effect of a blast wave, one of its important characteristics is the overpressure. The varia-

tion in the overpressure with time and distance will be described in succeeding sections. The maximum value, i.e., at the blast wave (or shock) front, is called the "peak overpressure." Other characteristics of the blast wave, such as dynamic pressure, duration, and time of arrival will also be discussed.

3.03 As stated in Chapter II, the expansion of the intensely hot gases at extremely high pressures in the fireball causes a shock wave to form, moving outward at high velocity. The main characteristic of this wave is that the pressure rises very sharply at the moving front and falls off toward the interior region of the explosion. In the very early stages, for example, the variation of the pressure with distance from the center of the fireball, at a given instant, is somewhat as illustrated in Fig. 3.03 for an ideal (instantaneously rising) shock front. It is seen that, prior to breakaway (§ 2.120), pressures at the shock front are two or three times as large as the already very high pressures in the interior of the fireball.

3.04 As the blast wave travels in the air away from its source, the overpressure at the front steadily decreases, and

the pressure behind the front falls off in a regular manner. After a short time, when the shock front has traveled a certain distance from the fireball, the pressure behind the front drops below that of the surrounding atmosphere and

a so-called "negative phase" of the blast wave forms. This development is seen in Fig. 3.04, which shows the overpressures at six successive times, indicated by the numbers 1, 2, 3, 4, 5, and 6. In the curves marked t_1 through t_5

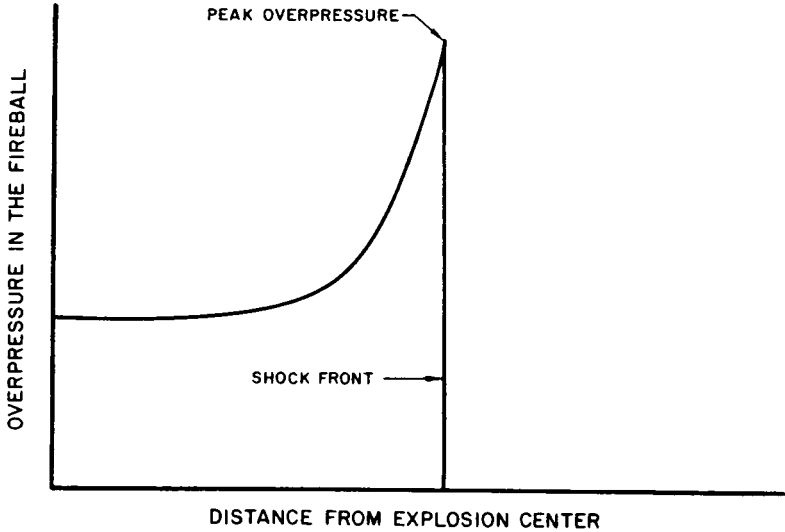

Figure 3.03. Variation of overpressure with distance in the fireball.

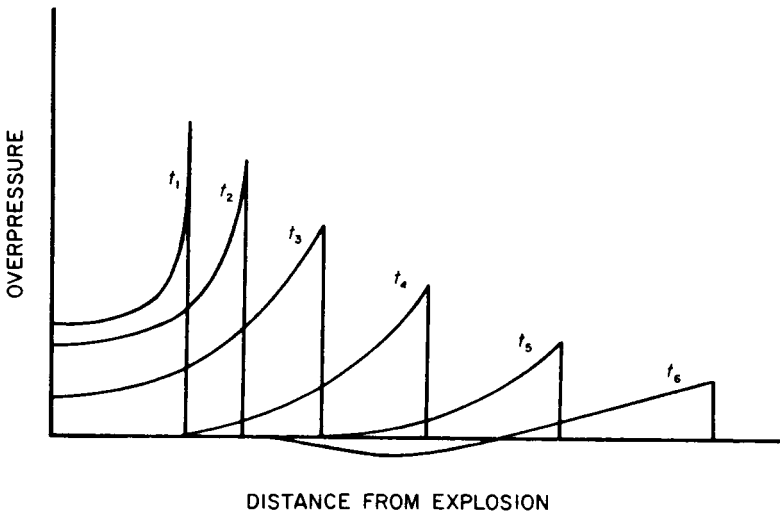

Figure 3.04. Variation of overpressure in air with distance at successive times.

the pressure in the blast wave has not fallen below atmospheric, but in the curve marked t_6 it is seen that at some distance behind the shock front the overpressure has a negative value. In this region the air pressure is below that of the original (or ambient) atmosphere, so that an "underpressure" rather than an overpressure exists.

3.05 During the negative (rarefaction or suction) phase, a partial vacuum is produced and the air is sucked in, instead of being pushed away from the explosion as it is when the overpressure is positive. At the end of the negative phase, which is somewhat longer than the positive phase, the pressure has essentially returned to ambient. The peak (or maximum) values of the underpressure are usually small compared with the peak positive overpressures; the former are generally not more than about 4 pounds per square inch below the ambient pressure whereas the positive overpressure may be much larger. With increasing distance from the explosion, both peak values decrease, the positive more rapidly than the negative,

and they approach equality when the peak pressures have decayed to a very low level.

THE DYNAMIC PRESSURE

3.06 The destructive effects of the blast wave are frequently related to values of the peak overpressure, but there is another important quantity called the "dynamic pressure." For a great variety of building types, the degree of blast damage depends largely on the drag force associated with the strong winds accompanying the passage of the blast wave. The drag force is influenced by certain characteristics—primarily the shape and size—of the structure, but this force also depends on the peak value of the dynamic pressure and its duration at a given location.

3.07 The dynamic pressure is proportional to the square of the wind velocity and to the density of the air behind the shock front. Both of these quantities may be related to the overpressure under ideal conditions at the wave front by certain equations, which will be given later (see § 3.55). For very

Table 3.07

PEAK OVERPRESSURE AND DYNAMIC PRESSURE AND MAXIMUM WIND VELOCITY IN AIR AT SEA LEVEL CALCULATED FOR AN IDEAL SHOCK FRONT

Peak overpressure (pounds per square inch)	Peak dynamic pressure (pounds per square inch)	Maximum wind velocity (miles per hour)
200	330	2,078
150	222	1,777
100	123	1,415
72	74	1,168
50	41	934
30	17	669
20	8.1	502
10	2.2	294
5	0.6	163
2	0.1	70

strong shocks the peak dynamic pressure is larger than the peak overpressure, but below 70 pounds per square inch overpressure at sea level the dynamic pressure is the smaller. Like the peak shock overpressure, the peak dynamic pressure generally decreases with increasing distance from the explosion center, although at a different rate. Some peak dynamic pressures and maximum blast wind velocities corresponding to various peak overpressures, as calculated for an ideal shock front in air at sea level (§ 3.53 *et seq.*) are given in Table 3.07. The results are based on 1,116 feet per second (761 miles per hour) as the velocity of sound in air (see Table 3.66).

3.08 The winds referred to above, which determine the dynamic pressure in the shock wave, are a direct consequence of the air blast. More will be said about these winds shortly. There are also other winds associated with nuclear explosions. These include the afterwinds mentioned in § 2.09, and the firestorms which will be described in Chapter VII.

CHANGES IN THE BLAST WAVE WITH TIME

3.09 From the practical standpoint, it is of interest to examine the changes of overpressure and dynamic pressure with time at a fixed location (or observation point). For a short interval after the detonation, there will be no change in the ambient pressure because it takes some time for the blast wave to travel from the point of the explosion to the given location. This time interval (or arrival time) depends upon the energy yield of the explosion and the slant

range. For example, at a distance of 1 mile from a 20-kiloton explosion in the air the arrival time would be about 3 seconds, whereas at 2 miles it would be about 7.5 seconds. The corresponding times for a 1-megaton burst would be roughly 1.4 and 4.5 seconds, respectively.

3.10 It is evident that the blast wave from an explosion of higher yield will arrive at a given point sooner than one for a lower yield. The higher the overpressure at the shock front, the greater is the velocity of the shock wave (see Figure. 3.55). Initially, this velocity may be quite high, several times the speed of sound in air (about 1,100 feet per second at sea level). As the blast wave progresses outward, the pressure at the front decreases and the velocity falls off accordingly. At long ranges, when the overpressure has decreased to less than about 1 pound per square inch, the velocity of the blast wave approaches the ambient speed of sound.

3.11 When the (ideal) shock front arrives at the observation point, the overpressure will increase sharply from zero to its maximum (or peak) value. Subsequently the overpressure decreases, as indicated by the upper curve in Fig. 3.11. The overpressure drops to zero in a short time, and this marks the end of the positive (or compression) phase of the overpressure at the given location. The duration of the overpressure positive phase increases with the energy yield and the distance from the explosion. For a 20-kiloton air burst, for example, this phase lasts roughly 1 second to 1.4 seconds at slant ranges of 1 to 2 miles; for a 1-megaton explosion, the respective durations would be approximately 1.4 to 2.3 seconds.

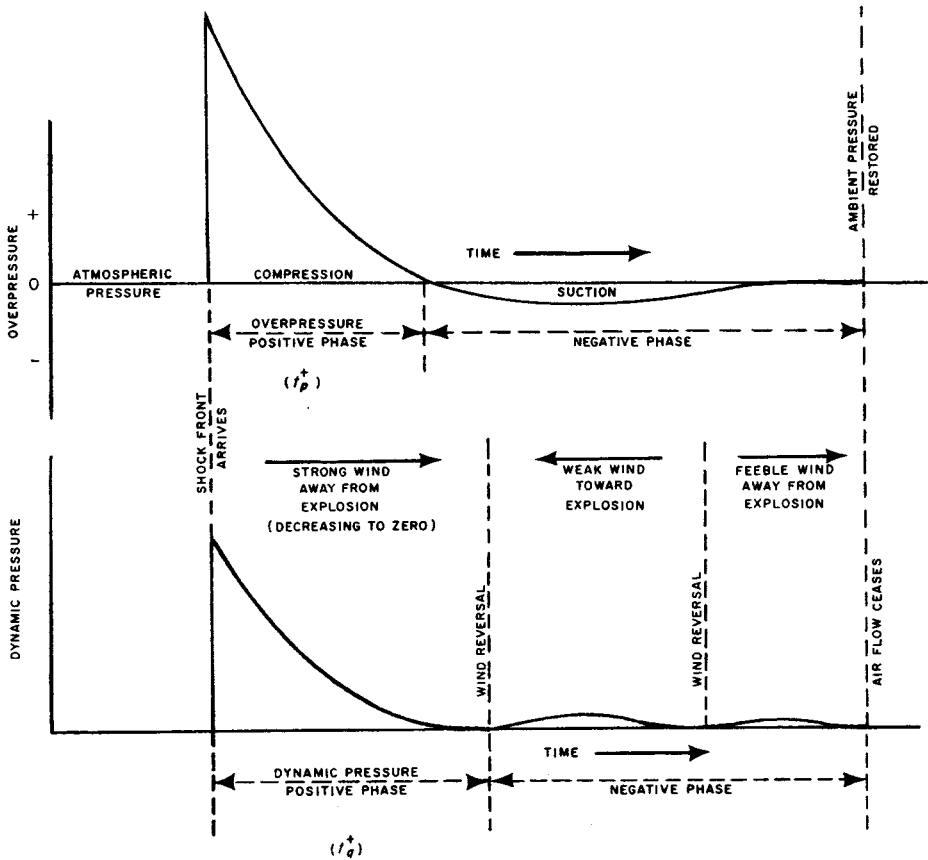

Figure 3.11. Variation of overpressure and dynamic pressure with time at a fixed location.

3.12 Provided the observation point is at a sufficient distance from the explosion, the overpressure will continue to decrease after it falls to zero so that it becomes negative. During this negative (or suction) phase, the pressure in the shock wave is less than the ambient atmospheric pressure. However, as seen in § 3.05, the underpressure is never very large. After decreasing gradually to a minimum value, the pressure starts to increase until it becomes equal to the normal atmospheric pressure, and the overpressure is zero again. The negative phase of the blast wave is usually longer

than the positive phase and it may last for several seconds. When this phase is ended, the blast wave will have passed the given observation point.

3.13 Changes in the wind and in the associated dynamic pressure accompany the changes with time of the overpressure. With the arrival of the shock front at a given location, a strong wind commences, blowing away from the explosion point. This blast wind is often referred to as a "transient wind" because its velocity decreases rapidly with time. The maximum velocity of the transient wind can be quite high, as indicated by

the values corresponding to various peak overpressures given in Table 3.07. The wind velocity decreases as the overpressure decreases, but it continues to blow for a time after the end of the positive overpressure phase (see Fig. 3.11). The reason is that the momentum of the air in motion behind the shock front keeps the wind blowing in the same direction even after the overpressure has dropped to zero and has started to become negative.

3.14 Since the dynamic pressure is related to the square of the wind velocity, the changes in the dynamic pressure with time will correspond to the changes in the wind just described. The dynamic pressure increases suddenly when the (ideal) shock front arrives at the observation point. Then it decreases, but drops to zero some time later than the overpressure, as shown by the lower curve in Fig. 3.11. The dynamic pressure positive phase is thus longer than the overpressure positive phase. The ratio of the dynamic pressure and overpressure positive phase durations depends on the pressure levels involved. When the peak pressures are high, the positive phase of the dynamic pressure may be more than twice as long as for the overpressure. At low peak pressures, on the other hand, the difference is only a few percent.

3.15 As a general rule, the peak overpressure and the peak dynamic pressure behind the shock front are quite different (see Table 3.07). Furthermore, the dynamic pressure takes somewhat longer than the overpressure to drop to zero during the positive phase. Consequently, it is evident that the overpressure and dynamic pressure at a given location change at different rates with

time. This matter will be discussed more fully later in this chapter (§ 3.57 *et seq.*).

3.16 By the time the wind ceases blowing away from the explosion, the overpressure is definitely negative (see Fig. 3.11); that is to say, the pressure in the blast wave is less than the ambient atmospheric pressure. Hence, air is drawn in from outside and, as a result, the wind starts to blow in the opposite direction, i.e., toward the explosion, but with a relatively small velocity. A short time after the overpressure minimum is passed, the wind again reverses direction and blows, once more, away from the explosion point. The feeble wind apparently results from expansion of the air due to an increase of temperature that occur at this stage.

3.17 The changes in the dynamic pressure corresponding to the foregoing wind changes after the end of the dynamic pressure positive phase are indicated in Fig. 3.11. The dynamic pressure finally decreases to zero when the ambient atmospheric pressure is restored and the blast wave has passed the observation point.

3.18 It should be noted that the dynamic pressure remains positive (or zero) even when the overpressure is negative. Since the overpressure is the difference between the actual blast wave pressure and the ambient atmospheric pressure, a negative overpressure merely implies that the actual pressure is less than the atmospheric pressure. The dynamic pressure, on the other hand, is an actual pressure without reference to any other pressure. It is a measure of the kinetic energy, i.e., energy of motion, of a certain volume of air behind the shock front (§ 3.55). The dynamic

pressure is consequently positive if the air is moving or zero if it is not; the direction in which the pressure acts depends on the direction of motion, i.e., the wind direction (see Fig. 3.11).

3.19 Nearly all the direct damage caused by both overpressure and dynamic pressure occurs during the positive overpressure phase of the blast wave. Although the dynamic pressure persists for a longer time, its magnitude during this additional time is usually so low that the destructive effects are not very significant. The damage referred to here is that caused directly by the blast wave. This will be largely terminated by the end of the overpressure positive phase, but the indirect destructive ef-

fects, e.g., due to fire (see Chapter VII), may continue long after the blast wave has passed.

3.20 There may be some direct damage to structures during the negative phase of the overpressure; for example, large windows which are poorly held against outward motion, brick veneer, and plaster walls may be dislodged by trapped air at normal pressure. But the maximum underpressure (and corresponding dynamic pressure) is generally quite small in comparison with the peak pressures at the shock front; hence, there is usually much less direct damage in the negative than in the positive overpressure phase of the blast wave.

REFLECTION OF BLAST WAVE AT A SURFACE

INCIDENT AND REFLECTED WAVES

3.21 When the incident blast wave from an explosion in air strikes a more dense medium such as the earth's surface, e.g., either land or water, it is reflected. The formation of the reflected wave in these circumstances is represented in Fig. 3.21. This figure shows four stages in the outward motion of the spherical blast wave originating from an air burst. In the first stage the wave front has not reached the ground; the second stage is somewhat later in time, and in the third stage, which is still later, a reflected wave, indicated by the dashed line, has been produced.

3.22 When such reflection occurs, an individual or object precisely at the

surface will experience a single pressure increase, since the reflected wave is formed instantaneously. Consequently, the overpressure at the surface is generally considered to be entirely a reflected pressure. For a smooth (or ideal) surface, the total reflected overpressure in the region near ground zero will be more than twice the value of the peak overpressure of the incident blast wave. The exact value of the peak reflected pressure will depend on the strength of the incident wave (§ 3.56) and the angle at which it strikes the surface (§ 3.78). The nature of the surface also has an important effect (§ 3.47), but for the present the surface is assumed to be smooth so that it acts as an ideal reflector. The variation in overpressure with time, as observed at a point actually on

the surface not too far from ground zero,¹ such as A in Fig. 3.21, is depicted in Fig. 3.22 for an ideal shock front. The point A may be considered as lying within the region of "regular" reflection, i.e., where the incident and reflected waves do not merge except on the surface.

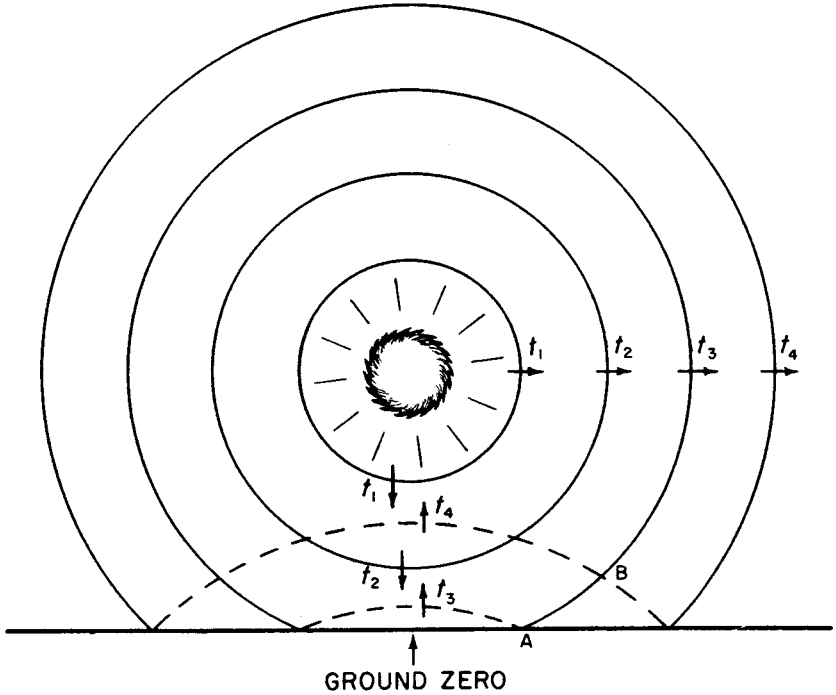

Figure 3.21. Reflection of blast wave at the earth's surface in an air burst; t_1 to t_4 represent successive times.

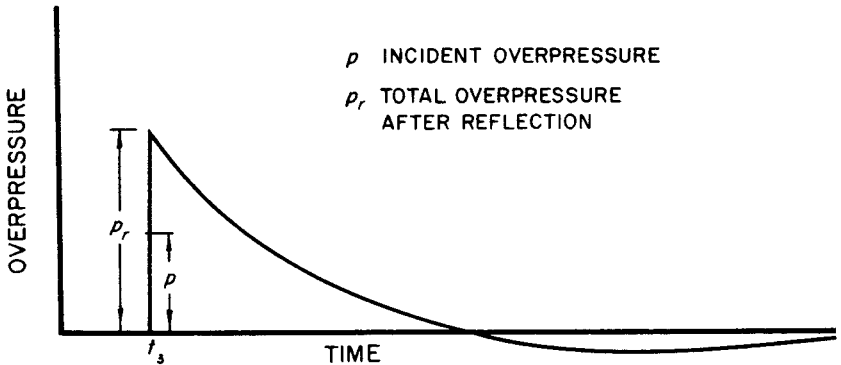

Figure 3.22. Variation of overpressure with time at a point on the surface in the region of regular reflection.

¹For an explanation of the term "ground zero," see § 2.34.

3.23 At any location somewhat above the surface in this region, two separate shocks will be felt, the first being due to the incident blast wave and the second to the reflected wave, which arrives a short time later (Fig. 3.23). This situation can be illustrated by considering the point B in Fig. 3.21, also in the regular reflection region. When the incident wave front reaches this point, at time t_3 , the reflected wave is still some distance away. There will, consequently, be a short interval before the reflected wave reaches the point above the surface at time t_4 . Between t_3 and t_4 , the reflected wave has spread out to some extent, so that its peak overpressure will be less than the value obtained at surface level. In determining the effects of air blast on structures in the regular reflection region, it may be necessary to consider the magnitude and also the directions of motion of both the incident and reflected waves. After passage of the reflected wave, the transient wind direction near the surface becomes essentially horizontal.

3.24 The following discussion concerning the delay between the arrival of the incident and reflected wave fronts at

a point above the surface, such as B in Fig. 3.21, is based on the tacit assumption that the two waves travel with approximately equal velocities. This assumption is reasonably justified in the early stages, when the wave front is not far from ground zero. However, it will be evident that the reflected wave always travels through air that has been heated and compressed by the passage of the incident wave. As a result, the reflected wave front moves faster than the incident wave and, under certain conditions, eventually overtakes it so that the two wave fronts merge to produce a single front. This process of wave interaction is called "Mach" or "irregular" reflection. The region in which the two waves have merged is therefore called the Mach (or irregular) region in contrast to the regular region where they have not merged.

3.25 The merging of the incident and reflected waves is indicated schematically in Fig. 3.25, which shows a portion of the profile of the blast wave close to the surface. The situation at a point fairly close to ground zero, such as A in Fig. 3.21, is represented in Fig. 3.25a. At a later stage, farther from

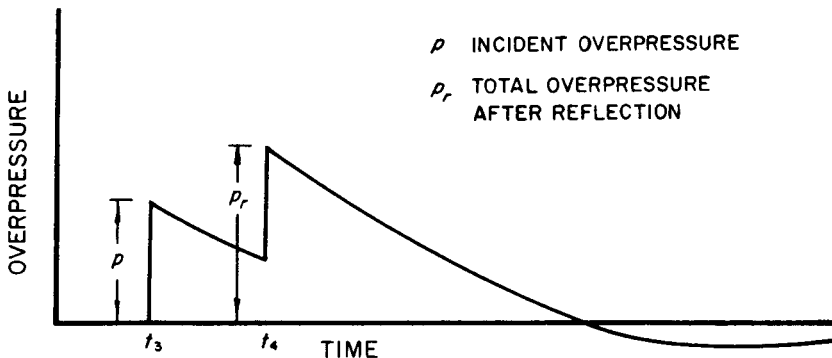

Figure 3.23. Variation of overpressure with time at a point above the surface in the region of regular reflection.

ground zero, as in Fig. 3.25b, the steeper front of the reflected wave shows that it is traveling faster than, and is overtaking, the incident wave. At the stage represented by Fig. 3.25c, the reflected wave near the ground has overtaken and merged with the incident wave to form a single front called the "Mach stem." The point at which the incident wave, reflected wave, and Mach fronts meet is referred to as the "triple point."² The configuration of

the three shock fronts has been called the "Mach Y."

3.26 As the reflected wave continues to overtake the incident wave, the triple point rises and the height of the Mach stem increases (Fig. 3.26). Any object located either at or above the ground, within the Mach region and below the triple point path, will experience a single shock. The behavior of this merged (or Mach) wave is the same as that previously described for blast

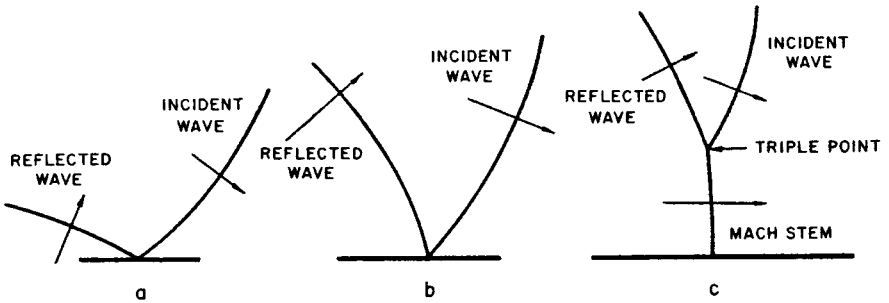

Figure 3.25. Merging of incident and reflected waves and formation of Mach Y configuration of shock fronts.

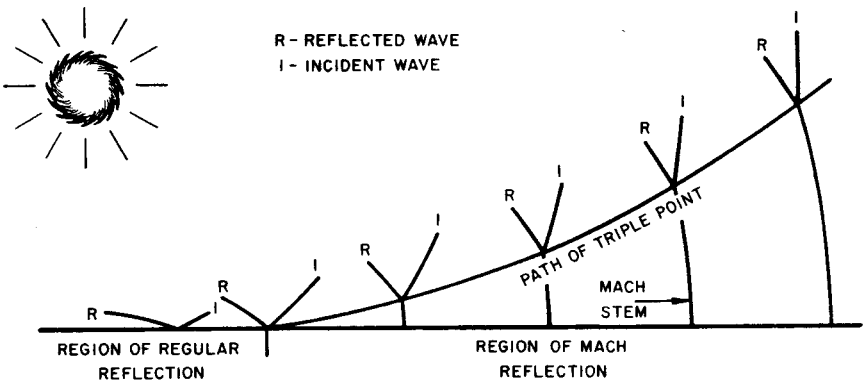

Figure 3.26. Outward motion of the blast wave near the surface in the Mach region.

²At any instant the so-called "triple point" is not really a point, but a horizontal circle with its center on the vertical line through the burst point; it appears as a point on a sectional (or profile) drawing, such as Fig. 3.25c.

waves in general. The overpressure at a particular location will fall off with time and the positive (compression) phase will be followed by a negative (suction) phase in the usual manner.

3.27 At points in the air above the triple point path, such as at an aircraft or at the top of a high building, two pressure increases will be felt. The first will be due to the incident blast wave and the second, a short time later, to the reflected wave. When a weapon is detonated at the surface, i.e., in a contact surface burst (§ 2.127 footnote), only a single merged wave develops. Consequently, only one pressure increase will be observed either on or above the ground.

3.28 As far as the destructive action of the air blast is concerned, there are at least two important aspects of the reflection process to which attention should be drawn. First, only a single pressure increase is experienced in the Mach region below the triple point as compared to the separate incident and reflected waves in the region of regular reflection. Second, since the Mach stem is nearly vertical, the accompanying blast wave is traveling in a horizontal direction at the surface, and the transient winds are approximately parallel to the ground (Fig. 3.25). Thus, in the Mach region, the blast forces on aboveground structures and other objects are directed nearly horizontally, so that vertical surfaces are loaded more intensely than horizontal surfaces.

3.29 The distance from ground zero at which the Mach stem begins to form depends primarily upon the yield of the detonation and the height of the burst above the ground. Provided the height of burst is not too great, the Mach stem forms at increasing distances from

ground zero as the height of burst increases for a given yield, and also as the yield decreases at a specified height of burst. For moderate heights of burst, Mach merging of direct and reflected waves occurs at a distance from ground zero approximately equal to the burst height. As the height of burst is increased, the distance from ground zero at which the Mach effect commences exceeds the burst height by larger and larger amounts.

HEIGHT OF BURST AND BLAST DAMAGE

3.30 The height of burst and energy yield of the nuclear explosion are important factors in determining the extent of damage at the surface. These two quantities generally define the variation of pressure with distance from ground zero and other associated blast wave characteristics, such as the distance from ground zero at which the Mach stem begins to form. As the height of burst for an explosion of given energy yield is decreased, or as the energy yield for a given height of burst increases, the consequences are as follows: (1) Mach reflection commences nearer to ground zero, and (2) the overpressure at the surface near ground zero becomes larger. An actual contact surface burst leads to the highest possible overpressures near ground zero. In addition, cratering and ground shock phenomena are observed, as will be described in Chapter VI.

3.31 Because of the relation between height of burst and energy of the explosion, the air blast phenomena to be expected on the ground from a weapon of large yield detonated at a height of a few thousand feet will approach those of

a near surface burst. On the other hand, explosions of weapons of smaller energy yields at these same or even lower levels will have the characteristics of air bursts. A typical example of the latter situation is found in the nuclear explosion which occurred over Nagasaki, Japan, in World War II when a weapon having a yield of approximately 22 kilotons of TNT equivalent was detonated at a height of about 1,640 feet. By means of certain rules, called "scaling laws," which are described in the technical section of this chapter (§ 3.60 *et seq.*), it is found that to produce similar blast phenomena at ground distances proportional to the heights of burst, for a 1-kiloton weapon the height of burst would have to be roughly 585 feet and for a 1-megaton explosion about 5,850 feet. In these three cases, the Mach stem formation would occur at distances from ground zero that are not very different from the respective heights of burst.

3.32 It should be noted that there is no single optimum height of burst, with regard to blast effects, for any specified explosion yield because the chosen burst height will be determined by the nature of the target. As a rule, strong (or hard) targets will require the equivalent of a low air burst or a surface burst. For weaker targets, which are destroyed or damaged at relatively low overpressures or dynamic pressures, the height of burst may be raised to increase the damage areas, since the required pressures will extend to a larger range than for a low air or surface burst.

3.33 The variation of blast characteristics with distance from ground zero for air bursts occurring at different heights are most conveniently represented by what are called "height of

burst" curves. Such curves have been prepared for various blast wave properties, e.g., peak overpressure, peak dynamic pressure, time of arrival, and positive phase duration, and will be presented and discussed later (§ 3.69 *et seq.*). Values of these (and other) properties can be determined from the curves, by application of appropriate scaling factors, for any explosion yield and height of burst.

CONTACT SURFACE BURST

3.34 The general air blast phenomena resulting from a contact surface burst are somewhat different from those for an air burst as described above. In a surface explosion the incident and reflected shock waves merge instantly, as seen in § 3.27, and there is no region of regular reflection. All objects and structures on the surface, even close to ground zero, are thus subjected to air blast similar to that in the Mach region below the triple point for an air burst. For an ideal (absolutely rigid) reflecting surface the shock wave characteristics, i.e., overpressure, dynamic pressure, etc., at the shock front would correspond to that for a "free air" burst, i.e., in the absence of a surface, with twice the energy yield. Behind the front, the various pressures would decay in the same manner as for an air burst. Because of the immediate merging of the incident and reflected air blast waves, there is a single shock front which is hemispherical in form, as shown at successive times, t_1 through t_4 , in Figure 3.34. Near the surface, the wave front is essentially vertical and the transient winds behind the front will blow in a horizontal direction.

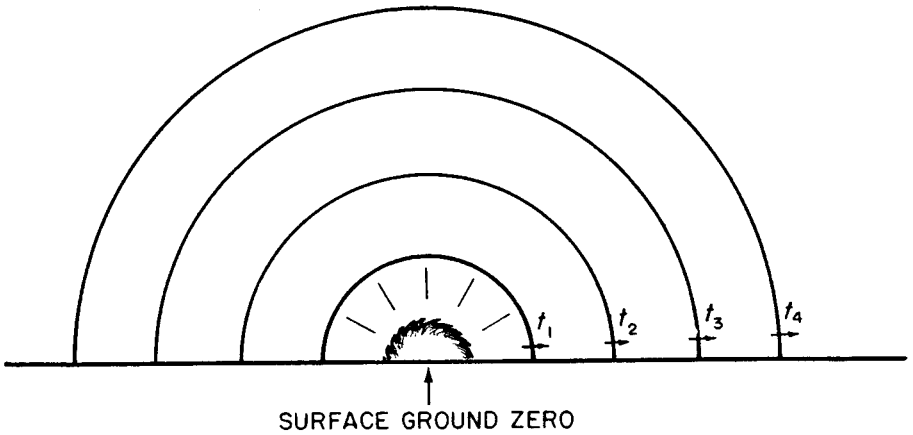

Figure 3.34. Blast wave from a contact surface burst; incident and reflected waves coincide.

MODIFICATION OF AIR BLAST PHENOMENA

TERRAIN EFFECTS

3.35 Large hilly land masses tend to increase air blast effects in some areas and to decrease them in others. The change in peak overpressure appears to depend on the slope angle and on the actual value of the pressure. The increase (or "spike") in peak overpressure which occurs at the base of a hill is attributable to the reflection of the blast wave by the front slope. This spike tends to broaden or lengthen with time as the wave travels up the hill. However, a reduction in peak overpressure occurs as the blast wave moves over the crest and down the back slope. The pressure at the wave front does not rise instantaneously, as in an ideal shock wave (see Fig. 3.11), but somewhat more gradually, although the behavior soon becomes normal as the blast wave proceeds down the hill. In general, the

variation in peak overpressure at any point on a hill from that expected if the hill were not present depends on the dimensions of the hill with respect to the energy yield and location of the explosion. Since the time interval in which the pressure increase or decrease occurs is short compared to the length of the positive phase, the effects of terrain on the blast wave are not expected to be significant for a large variety of structural types.

3.36 It is important to emphasize, in particular, that shielding from blast effects behind the brow of a large hill is not dependent upon line-of-sight considerations. In other words, the fact that the point of the explosion cannot be seen from behind the hill by no means implies that the blast effects will not be felt. It will be shown in Chapter IV that blast waves can easily bend (or diffract) around apparent obstructions.

3.37 Although prominent terrain features may shield a particular target from thermal radiation, and perhaps also to some extent from the initial nuclear radiation, little reduction in blast damage to structures may be expected, except in very special circumstances. Nevertheless, considerable protection from debris and other missiles (§ 3.50) and drag forces may be achieved for such movable objects as heavy construction equipment by placing them below the surface of the ground in open excavations or deep trenches or behind steep earth mounds.

3.38 The departure from idealized or flat terrain presented by a city complex may be considered as an aspect of topography. It is to be expected that the presence of many buildings close together will cause local changes in the blast wave, especially in the dynamic pressure. Some shielding may result from intervening objects and structures; however, in other areas multiple reflections between buildings and the channeling caused by streets may increase the overpressure and dynamic pressure.

METEOROLOGICAL CONDITIONS

3.39 The presence of large amounts of moisture in the atmosphere may affect the properties of a blast wave in the low overpressure region. But the probability of encountering significant concentrations of atmospheric liquid water that would influence damage is considered to be small. Meteorological conditions, however, can sometimes either enlarge or contract the area over which light structural damage would normally be expected. For example, window breakage and noise have been experi-

enced hundreds of miles from the burst point. Such phenomena, which have been observed with large TNT detonations as well as with nuclear explosions, are caused by the bending back to the earth of the blast wave by the atmosphere.

3.40 Four general conditions which can lead to this effect are known. The first is a temperature "inversion" near the earth's surface. Normally, the air temperature in the lower atmosphere (troposphere) decreases with increasing altitude in the daytime. In some cases, however, the temperature near the surface increases instead of decreasing with altitude; this is called a temperature inversion. It can arise either from nighttime cooling of the ground surface by the radiation of heat or from a mass of warm air moving over a relatively cold surface. The result of an inversion is that the overpressure on the ground at a distance from the explosion may be higher than would otherwise be expected. Conversely, when unstable conditions prevail, and the temperature near the earth's surface decreases rapidly with altitude, as in the afternoon or in tropical climates, the blast wave is bent away from the ground. The overpressure then decays with distance faster than expected.

3.41 The second situation exists when there are high-speed winds aloft. If the normal decrease in the temperature of the air with increasing altitude is combined with an upper wind whose speed exceeds 3 miles per hour for each 1,000 feet of altitude, the blast wave will be refracted (or bent) back to the ground. This usually occurs with jet-stream winds, where maximum velocities are found between 25,000- and

50,000-foot altitudes. These conditions may cause several "rays" to converge into a sharp focus at one location on the ground, and the concentration of blast energy there will greatly exceed the value that would otherwise occur at that distance. The first (or direct striking) focus from a jet stream duct may be at 20 to 50 miles from the explosion. Since the blast energy is reflected from the ground and is again bent back by the atmosphere, the focus may be repeated at regularly spaced distances. In an explosion of a 20-kiloton weapon in the air at the Nevada Test Site, this effect caused windows to break 75 to 100 miles away.

3.42 Bending of blast waves in the downwind direction can also be produced by a layer of relatively warm air at a height of 20 to 30 miles in the lower mesosphere (see Fig. 9.126). In these levels winds blow from the west in winter and from east in summer, enhancing blast pressures and noise at downwind distances from 70 to 150 miles (first direct strike). Reflections from the ground, and subsequent refractions by the lower mesosphere, cause the usual repeat focus pattern. Focusing of this type has resulted in the breakage of windows on the second ground strike at 285 miles downwind from a 17-kiloton nuclear air burst. Large explosions have been distinctly heard at even greater distances.³

3.43 The fourth condition is brought about by the very high temperatures in the thermosphere, the region of the atmosphere above an altitude of about 60 miles (Fig. 9.126). Blast waves are ducted in the thermosphere so

that they reach the ground at distances beyond 100 miles from the burst, generally in the opposite direction from the principal mesospheric signals, i.e., in the upwind direction. Most of the blast wave energy is absorbed in the low-density air at high altitudes, and no structural damage has been reported from thermospheric ducting. However, sharp pops and crackles have been heard when the waves from large explosions reach the ground.

EFFECT OF ALTITUDE

3.44 The relations between overpressure, distance, and time that describe the propagation of a blast wave in air depend upon the ambient atmospheric conditions, and these vary with the altitude. In reviewing the effects of elevation on blast phenomena, two cases will be considered; one in which the point of burst and the target are essentially at the same altitude, but not necessarily at sea level, and the second, when the burst and target are at different altitudes.

3.45 For an air burst, the peak overpressure at a given distance from the explosion will depend on the ambient atmospheric pressure and this will vary with the burst altitude. There are a number of simple correction factors, which will be given later (§ 3.65 *et seq.*), that can be used to allow for differences in the ambient conditions, but for the present it will be sufficient to state the general conclusions. With increasing altitude of both target and burst point, the overpressure at a given distance from an explosion of specified

³The situations described here and in § 3.43 could also be considered as temperature inversions.

yield will generally decrease. Correspondingly, an increase may usually be expected in both the arrival time of the shock front and in the duration of the positive phase of the blast wave. For elevations of less than 5,000 feet or so above sea level, the changes are small, and since most surface targets are at lower altitudes, it is rarely necessary to make the corrections.

3.46 The effect when the burst and target are at different elevations, such as for a high air burst, is somewhat more complex. Since the blast wave is influenced by changes in air temperature and pressure in the atmosphere through which it travels, some variations in the pressure-distance relationship at the surface might be expected. Within the range of significant damaging overpressures, these differences are small for weapons of low energy yield. For weapons of high yield, where the blast wave travels over appreciably longer distances, local variations, such as temperature inversions and refraction, may be expected. Consequently, a detailed knowledge of the atmosphere on a particular day would be necessary in order to make precise calculations. For planning purposes, however, when the target is at an appreciable elevation above sea level the ambient conditions at the target altitude are used to evaluate the correction factors referred to above.

SURFACE EFFECTS

3.47 For a given height of burst and explosion energy yield, some variation in blast wave characteristics may be expected over different surfaces. These variations are determined primarily by the type and extent of the surface over

which the blast wave passes. In considering the effects of the surface, a distinction is made between ideal (or nearly ideal) and nonideal surface conditions. An "ideal" surface is defined as a perfectly flat surface that reflects all (and absorbs none) of the energy, both thermal (heat) and blast, that strikes it. No area of the earth's surface is ideal in this sense, but some surfaces behave almost like ideal surfaces and they are classified as "nearly ideal." For an ideal (or nearly ideal) surface the properties of the blast wave are essentially free of mechanical and thermal effects. If the surface is such that these effects are significant, it is said to be "nonideal."

3.48 The terrain phenomena described in § 3.35 *et seq.* are examples of mechanical factors that can change the characteristics of the blast wave. In general, the nature of the reflecting surface can affect the peak overpressure and the formation and growth of the Mach stem. Absorption of some of the blast energy in the ground, which will be considered in § 3.51, is to be regarded as another type of mechanical effect on the blast wave due to a non-ideal surface.

3.49 Many surfaces, especially when the explosion can raise a cloud of dust, are nonideal because they absorb substantial amounts of heat energy. In these circumstances, the properties of the blast wave may be modified by the formation of an auxiliary wave, called a "precursor," that precedes the main incident wave. The characteristics of the blast wave will then be quite different from those that would be observed on an ideal (or nearly ideal) surface. Precursor phenomena, which are complex, are discussed more fully in § 3.79 *et seq.*

3.50 Somewhat related to the condition of the surface are the effects of objects and material picked up by the blast wave. Damage may be caused by missiles such as rocks, boulders, and pebbles, as well as by smaller particles such as sand and dust. This particulate matter carried along by the blast wave does not necessarily affect the overpressures at the shock front. In dusty areas, however, the blast wave may pick up enough dust to increase the dynamic pressure over the values corresponding to the overpressure in an ideal blast wave. There may also be an increase in the velocity of air particles in the wave due to precursor action. Consequently, the effect on structures which are damaged mainly by dynamic pressure will be correspondingly increased, especially in regions where the precursor is strong.

GROUND SHOCK FROM AIR BLAST

3.51 Another aspect of the blast wave problem is the possible effect of an air burst on underground structures as a result of the transfer of some of the blast wave energy into the ground. A minor oscillation of the surface is experienced and a ground shock is produced. The strength of this shock at any point is determined by the overpressure in the

blast wave immediately above it. For large overpressures with long positive-phase duration, the shock will penetrate some distance into the ground, but blast waves which are weaker and of shorter duration are attenuated more rapidly. The major principal stress in the soil will be nearly vertical and about equal in magnitude to the air blast overpressure. These matters will be treated in more detail in Chapter VI.

3.52 For a high air burst, the blast overpressures are expected to be relatively small at ground level; the effects of ground shock induced by air blast will then be negligible. But if the overpressure at the surface is large, there may be damage to buried structures. However, even if the structure is strong enough to withstand the effect of the ground shock, the sharp jolt resulting from the impact of the shock wave can cause injury to occupants and damage to loose equipment. In areas where the air blast pressure is high, certain public utilities, such as sewer pipes and drains made of relatively rigid materials and located at shallow depths, may be damaged by earth movement, but relatively flexible metal pipe will not normally be affected. For a surface burst in which cratering occurs, the situation is quite different, as will be seen in Chapter VI.

TECHNICAL ASPECTS OF BLAST WAVE PHENOMENA⁴

PROPERTIES OF THE IDEAL BLAST WAVE

3.53 The characteristics of the blast wave have been discussed in a qualitative manner in the earlier parts of this

chapter, and the remaining sections will be devoted mainly to a consideration of some of the quantitative aspects of blast wave phenomena in air. The basic relationships among the properties of a blast wave having a sharp front at which there

⁴The remaining sections of this chapter may be omitted without loss of continuity.

is a sudden pressure discontinuity, i.e., a true (or ideal) shock front, are derived from the Rankine-Hugoniot conditions based on the conservation of mass, energy, and momentum at the shock front. These conditions, together with the equation of state for air, permit the derivation of the required relations involving the shock velocity, the particle (or wind) velocity, the overpressure, the dynamic pressure, and the density of the air behind the ideal shock front.

3.54 The blast wave properties in the region of regular reflection are somewhat complex and depend on the angle of incidence of the wave with the ground and the overpressure. For a contact surface burst, when there is but a single hemispherical (merged) wave, as stated in § 3.34, and in the Mach region below the triple point path for an air burst, the various blast wave characteristics at the shock front are uniquely related by the Rankine-Hugoniot equations. It is for these conditions, in which there is a single shock front, that the following results are applicable.

3.55 The shock velocity, U , is expressed by

$$U = c_0 \left(1 + \frac{\gamma + 1}{2\gamma} \cdot \frac{p}{P_0} \right)^{1/2},$$

where c_0 is the ambient speed of sound (ahead of the shock front), p is the peak overpressure (behind the shock front), P_0 is the ambient pressure (ahead of the shock), and γ is the ratio of the specific heats of the medium, i.e., air. If γ is taken as 1.4, which is the value at moderate temperatures, the equation for the shock velocity becomes

$$U = c_0 \left(1 + \frac{6p}{7P_0} \right)^{1/2}$$

The particle velocity (or peak wind velocity behind the shock front), u , is given by

$$u = \frac{c_0 p}{\gamma P_0} \left(1 + \frac{\gamma + 1}{2\gamma} \cdot \frac{p}{P_0} \right)^{-1/2}$$

so that for air

$$u = \frac{5p}{7P_0} \cdot \frac{c_0}{(1 + 6p/7P_0)^{1/2}}$$

The density, ρ , of the air behind the shock front is related to the ambient density, ρ_0 , by

$$\begin{aligned} \frac{\rho}{\rho_0} &= \frac{2\gamma P_0 + (\gamma + 1)p}{2\gamma P_0 + (\gamma - 1)p} \\ &= \frac{7 + 6p/P_0}{7 + p/P_0} \end{aligned}$$

The dynamic pressure, q , is defined by

$$q = \frac{1}{2} \rho u^2,$$

so that it is actually the kinetic energy per unit volume of air immediately behind the shock front; this quantity has the same dimensions as pressure. Introduction of the Rankine-Hugoniot equations for ρ and u given above leads to the relation

$$\begin{aligned} q &= \frac{p^2}{2\gamma P_0 + (\gamma - 1)p} \\ &= \frac{5}{2} \cdot \frac{p^2}{7P_0 + p} \quad (3.55.1) \end{aligned}$$

between the peak dynamic pressure in air and the peak overpressure and ambient pressure. The variations of shock velocity, particle (or peak wind) velocity, and peak dynamic pressure with the peak overpressure at sea level, as derived from the foregoing equations, are shown graphically in Fig. 3.55.

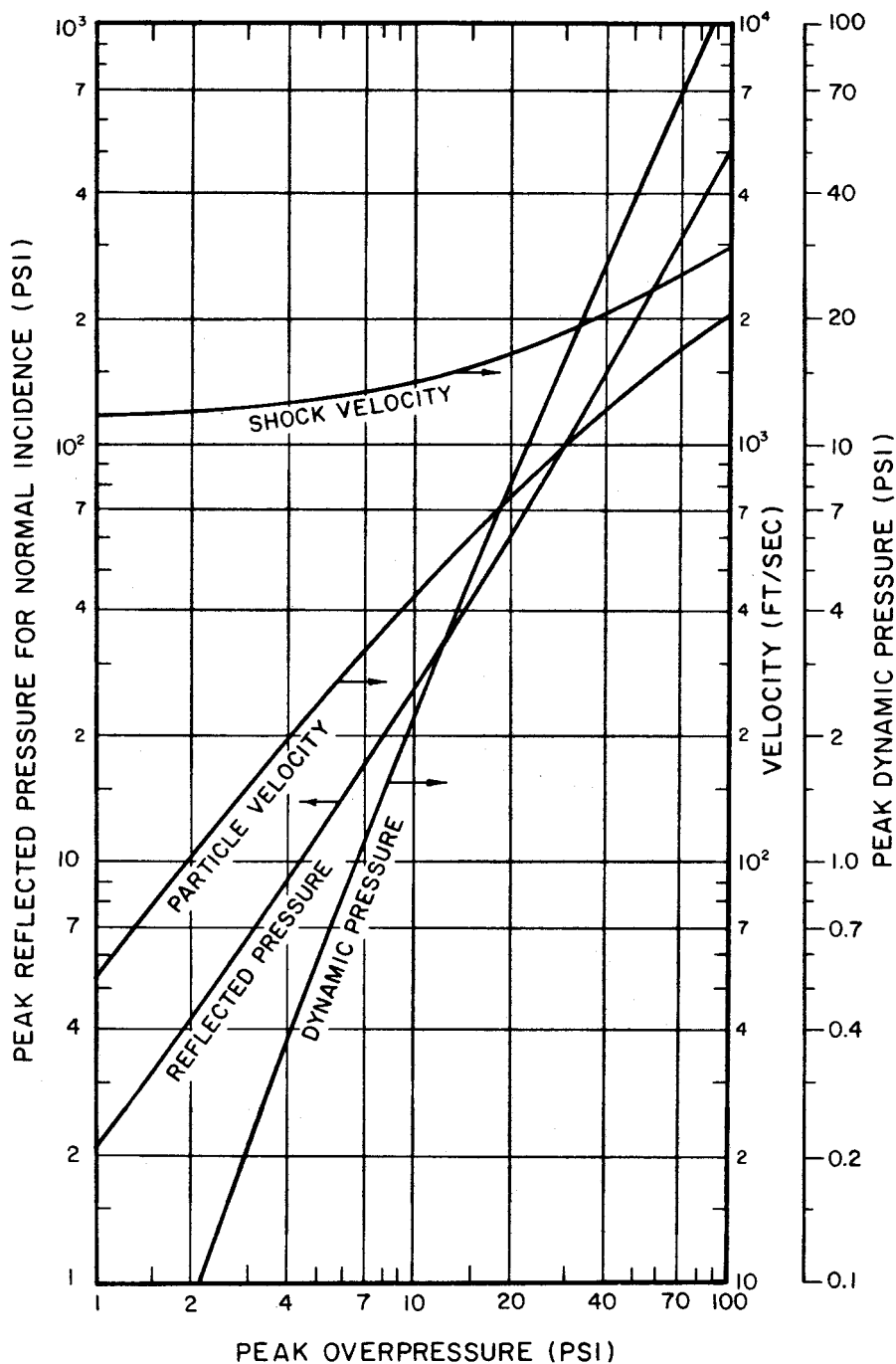

Figure 3.55. Relation of ideal blast wave characteristics at the shock front to peak overpressure.

3.56 When the blast wave strikes a flat surface, such as that of a structure, at normal incidence, i.e., head on, the instantaneous (peak) value of the reflected overpressure, p_r , is given by

$$p_r = 2p + (\gamma + 1)q. \quad (3.56.1)$$

Upon using equation (3.55.1) for air, this becomes

$$p_r = 2p \frac{7P_0 + 4p}{7P_0 + p} \quad (3.56.2)$$

It can be seen from equation (3.56.2) that the value of p_r approaches $8p$ for very large values of the incident overpressure and dynamic pressure (strong shocks), and tends toward $2p$ for small overpressures and small dynamic pressures (weak shocks). It is evident from equation (3.56.1) that the increase in the reflected overpressure above the expected value of twice the incident value, i.e., $2p$, is due to the dynamic (or wind) pressure. The reflected overpressure arises from the change of momentum when the moving air changes direction as a result of striking the surface. A curve showing the variation of the instantaneous (peak) reflected pressure, with the peak incident overpressure, for normal incidence on a flat surface, is included in Fig. 3.55.

3.57 The equations in § 3.55 give the peak values of the various blast parameters at the shock front. The variation of the overpressure at a given point with time after its arrival at that point has been obtained by numerical integration of the equations of motion and the results are represented in Fig. 3.57. In these curves the "normalized" overpressure, defined by $p(t)/p$, where $p(t)$ is the overpressure at time t after the ar-

rival of the shock front and p is the peak overpressure, is given as a function of the "normalized" time, t/t_p^+ , where t_p^+ is the duration of the overpressure positive phase. The parameter indicated on each curve is the peak overpressure to which that curve refers. It is seen, therefore, that the variation of the normalized (and actual) overpressure with time depends on the peak overpressure. Values of t_p^+ for various burst conditions are given in Fig. 3.76.

3.58 Similarly, the variation of the normalized dynamic pressure, $q(t)/q$, with the normalized time, t/t_q^+ , where t_q^+ is the duration of the dynamic pressure positive phase, depends on the peak value of the dynamic pressure. This is shown by the curves in Fig. 3.58 for several indicated values of the peak dynamic pressure; values of t_q^+ required for use with this figure will be found in Fig. 3.76. It should be noted that, since the duration of the dynamic pressure positive phase is somewhat longer than that for the overpressure, i.e., t_q^+ is longer than t_p^+ , Figs. 3.57 and 3.58 do not have a common time base.

3.59 Another important blast damage parameter is the "impulse," which takes into account the duration of the positive phase and the variation of the overpressure during that time. Impulse (per unit area) may be defined as the total area under the curve for the variation of overpressure with time. The positive phase overpressure impulse (per unit area), I_p^+ , may then be represented mathematically by

$$I_p^+ = \int_0^{t_p^+} p(t)dt,$$

where $p(t)$ is obtained from Fig. 3.57 for any overpressure between 3 and 3,000

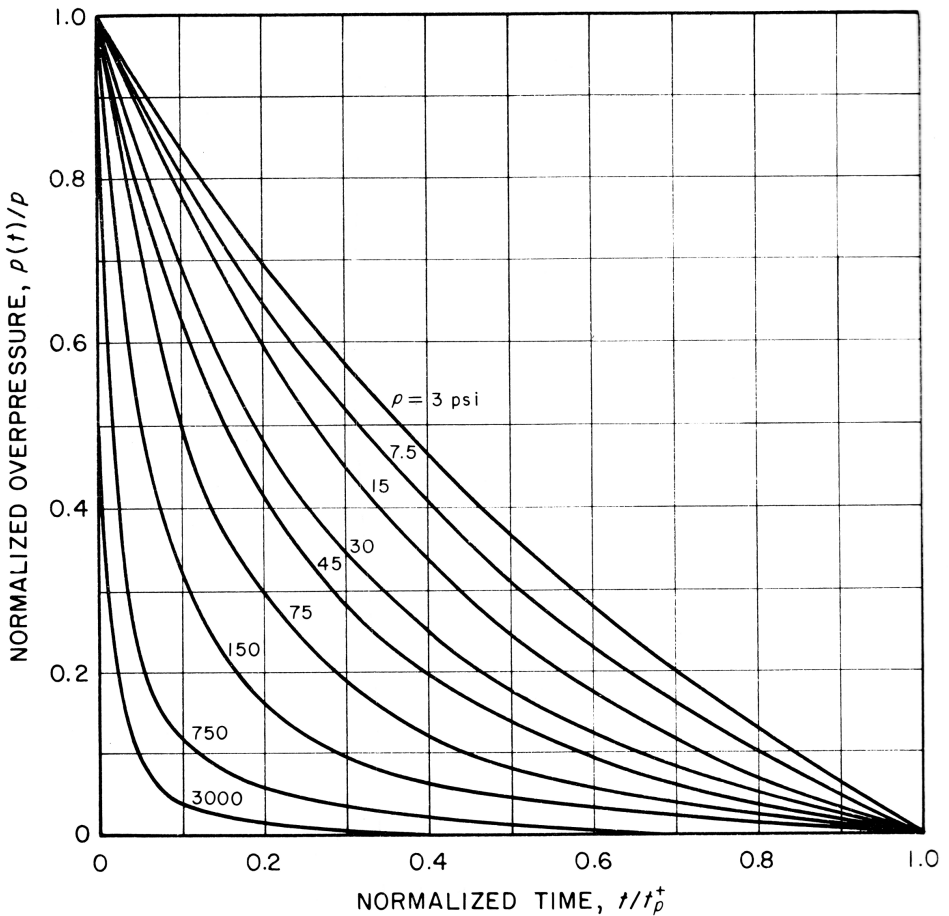

Fig. 3.57. Rate of decay of overpressure with time for several values of the peak overpressure.

psi. The positive phase dynamic impulse is defined by a similar expression in which $q(t)$ and t_q^+ replace $p(t)$ and t_p^+ , respectively.

SCALING LAWS

3.60 In order to calculate the characteristic properties of the blast wave from an explosion of any given energy if those for another energy are known, appropriate scaling laws are applied. With the aid of such laws it is possible to express the data for a large

range of energies in a simple form. One way of doing this, which will be illustrated below, is to draw curves showing how the various properties of the blast wave at the surface change with increasing distance from the detonation in the case of a 1-kiloton nuclear explosion. Then, with the aid of the scaling laws, the values for an explosion of any specified energy can be readily determined for a particular height of burst.

3.61 Theoretically, a given pressure will occur at a distance from an explosion that is proportional to the cube root

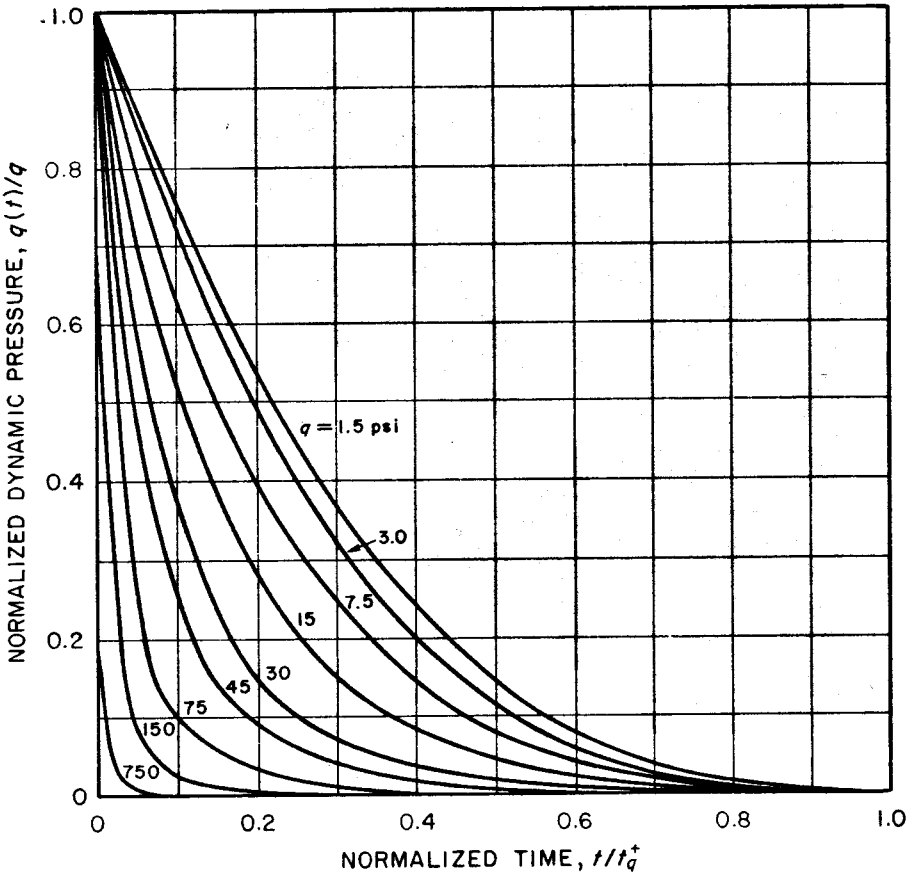

Fig. 3.58. Rate of decay of dynamic pressure with time for several values of the dynamic pressure.

of the energy yield. Full-scale tests have shown this relationship between distance and energy yield to hold for yields up to (and including) the megaton range. Thus, cube root scaling may be applied with confidence over a wide range of explosion energies. According to this law, if D_1 is the distance (or slant range) from a reference explosion of W_1 kilotons at which a certain overpressure or dynamic pressure is attained, then for any explosion of W kilotons energy these same pressures will occur at a distance D given by

$$\frac{D}{D_1} = \left(\frac{W}{W_1} \right)^{1/3} \quad (3.61.1)$$

As stated above, the reference explosion is conveniently chosen as having an energy yield of 1 kiloton, so that $W_1 = 1$. It follows, therefore, from equation (3.61.1) that

$$D = D_1 \times W^{1/3}, \quad (3.61.2)$$

where D_1 refers to the slant range from a 1-kiloton explosion. Consequently, if the distance D is specified, then the value of the explosion energy, W , re-

quired to produce a certain effect, e.g., a given peak overpressure, can be calculated. Alternatively, if the energy, W , is specified, the appropriate range, D , can be evaluated from equation (3.61.2).

3.62 When comparing air bursts having different energy yields, it is convenient to introduce a scaled height of burst, defined as

$$\text{Scaled height of burst} = \frac{\text{Actual height of burst}}{W^{1/3}}$$

For explosions of different energies having the same scaled height of burst, the cube root scaling law may be applied to distances from ground zero, as well as to distances from the explosion. Thus, if d_1 is the distance from ground zero at which a particular overpressure or dynamic pressure occurs for a 1-kiloton explosion, then for an explosion of W kilotons energy the same pressures will be observed at a distance d determined by the relationship

$$d = d_1 \times W^{1/3} \quad (3.62.1)$$

This expression can be used for calculations of the type referred to in the preceding paragraph, except that the distances involved are from ground zero instead of from the explosion (slant ranges).⁵

3.63 Cube root scaling can also be applied to arrival time of the shock front, positive phase duration, and positive phase impulse, with the understanding that the distances concerned are themselves scaled according to the cube root law. The relationships (for

bursts with the same scaled height) may be expressed in the form

$$\frac{t}{t_1} = \frac{d}{d_1} = \left(\frac{W}{W_1} \right)^{1/3}$$

and

$$\frac{I}{I_1} = \frac{d}{d_1} = \left(\frac{W}{W_1} \right)^{1/3},$$

where t_1 represents arrival time or positive phase duration and I_1 is the positive phase impulse for a reference explosion of energy W_1 , and t and I refer to any explosion of energy W ; as before, d_1 and d are distances from ground zero. If W_1 is taken as 1 kiloton, then the various quantities are related as follows:

$$t = t_1 \times W^{1/3} \text{ at a distance } d = d_1 \times W^{1/3}$$

and

$$I = I_1 \times W^{1/3} \text{ at a distance } d = d_1 \times W^{1/3}.$$

Examples of the use of the equations developed above will be given later.

ALTITUDE CORRECTIONS

3.64 The data presented (§ 3.55 *et seq.*) for the characteristic properties of a blast wave are strictly applicable to a homogeneous (or uniform) atmosphere at sea level. At altitudes below about 5,000 feet, the temperatures and pressures in the atmosphere do not change very much from the sea-level values. Consequently, up to this altitude, it is a reasonably good approximation to treat the atmosphere as being homogeneous with sea-level properties. The equations given above may thus be used without

⁵The symbol d is used for the distance from ground zero, whereas D refers to the slant range, i.e., the distance from the actual burst.

correction if the burst and target are both at altitudes up to 5,000 feet. If it is required to determine the air blast parameters at altitudes where the ambient conditions are appreciably different from those at sea level, appropriate correction factors must be applied.

3.65 The general relationships which take into account the fact that the absolute temperature T and ambient pressure P are not the same as T_0 and P_0 respectively, in the reference (1-kiloton) explosion in a sea-level atmosphere, are as follows. For the overpressure

$$p = p_1 \frac{P}{P_0}, \quad (3.65.1)$$

where p is the overpressure at altitude and p_1 is that at sea level. The corrected value of the distance from ground zero for the new overpressure level is then given by

$$d = d_1 W^{1/3} \left(\frac{P_0}{P} \right)^{1/3} \quad (3.65.2)$$

A similar expression is applicable to the slant range, D . The arrival time of positive phase duration at this new distance is

$$t = t_1 W^{1/3} \left(\frac{P_0}{P} \right)^{1/3} \left(\frac{T_0}{T} \right)^{1/2} \quad (3.65.3)$$

The factor $(T_0/T)^{1/2}$ appears in this expression because the speed of sound is proportional to the square root of the absolute temperature. For impulse at altitude, the appropriate relationship is

$$I = I_1 W^{1/3} \left(\frac{P}{P_0} \right)^{2/3} \left(\frac{T_0}{T} \right)^{1/2} \quad (3.65.4)$$

The foregoing equations are applicable when the target and burst point are at roughly the same altitude. If the altitude difference is less than a few thousand

feet, the temperature and pressure at a mean altitude may be used. But if the altitude difference is considerable, a good approximation is to apply the correction at the target altitude (§ 3.46). For bursts above about 40,000 feet, an allowance must be made for changes in the explosion energy partition (§ 3.67.)

3.66 In order to facilitate calculations based on the equations in the preceding paragraph, the following factors have been defined and tabulated (Table 3.66):

$$S_p = \frac{P}{P_0}$$

$$S_d = \left(\frac{P_0}{P} \right)^{1/3}$$

$$S_t = \left(\frac{P_0}{P} \right)^{1/3} \left(\frac{T_0}{T} \right)^{1/2},$$

so that

$$p = p_1 S_p \quad (3.66.1)$$

$$D = D_1 W^{1/3} S_d \text{ and} \\ d = d_1 W^{1/3} S_d \quad (3.66.2)$$

$$t = t_1 W^{1/3} S_t \quad (3.66.3)$$

$$I = I_1 W^{1/3} S_p S_t \quad (3.66.4)$$

The reference values P_0 and T_0 are for a standard sea-level atmosphere. The atmospheric pressure P_0 is 14.7 pounds per square inch and the temperature is 59°F or 15°C, so that T_0 is 519° Rankine or 288° Kelvin. In a strictly homogeneous atmosphere the altitude scaling factors S_p , S_d , and S_t would all be unity and equations (3.66.1), etc., would reduce to those in § 3.65. Below an altitude of about 5,000 feet the scaling factors do not differ greatly from unity and the approximation of a homogeneous (sea-level) atmosphere is not seriously in error, as mentioned above.

Table 3.66

AVERAGE ATMOSPHERIC DATA FOR MID-LATITUDES

Altitude (feet)	Temperature (degrees Kelvin)	Pressure (psi)	Altitude Scaling Factors			Speed of Sound (ft/sec)
			S_p	S_v	S_t	
0	288	14.70	1.00	1.00	1.00	1,116
1,000	286	14.17	0.96	1.01	1.02	1,113
2,000	284	13.66	0.93	1.03	1.03	1,109
3,000	282	13.17	0.90	1.04	1.05	1,105
4,000	280	12.69	0.86	1.05	1.07	1,101
5,000	278	12.23	0.83	1.06	1.08	1,097
10,000	268	10.11	0.69	1.13	1.17	1,077
15,000	258	8.30	0.56	1.21	1.28	1,057
20,000	249	6.76	0.46	1.30	1.39	1,037
25,000	239	5.46	0.37	1.39	1.53	1,016
30,000	229	4.37	0.30	1.50	1.68	995
35,000	219	3.47	0.24	1.62	1.86	973
40,000	217	2.73	0.19	1.75	2.02	968
45,000	217	2.15	0.15	1.90	2.19	968
50,000	217	1.69	0.12	2.06	2.37	968
55,000	217	1.33	0.091	2.23	2.57	968
60,000	217	1.05	0.071	2.41	2.78	968
65,000	217	0.83	0.056	2.61	3.01	968
70,000	218	0.65	0.044	2.83	3.25	971
75,000	219	0.51	0.035	3.06	3.50	974
80,000	221	0.41	0.028	3.31	3.78	978
85,000	222	0.32	0.022	3.57	4.07	981
90,000	224	0.25	0.017	3.86	4.38	984
95,000	225	0.20	0.014	4.17	4.71	988
100,000	227	0.16	0.011	4.50	5.07	991
110,000	232	0.10	0.0070	5.23	5.82	1,003
120,000	241	0.067	0.0045	6.04	6.61	1,021
130,000	249	0.044	0.0030	6.95	7.47	1,038
140,000	258	0.029	0.0020	7.95	8.41	1,056
150,000	266	0.020	0.0013	9.06	9.43	1,073

3.67 The correction factors in § 3.66 are applicable for burst altitudes up to about 40,000 feet (about 7.6 miles). Nearly all of the energy from nuclear explosions below this altitude is absorbed by air molecules near the burst. Deviations from the scaling laws described in the preceding paragraphs are caused principally by differences in

the partitioning of the energy components when the burst occurs above 40,000 feet. At such altitudes, part of the energy that would have contributed to the blast wave at lower altitudes is emitted as thermal radiation.

3.68 To allow for the smaller fraction of the yield that appears as blast energy at higher altitudes, the actual

yield is multiplied by a "blast efficiency factor" to obtain an effective blast yield. There is no simple way to formulate the blast efficiency factor as a function of altitude since, at high altitudes, overpressure varies with distance in such a manner that the effective blast yield is different at different distances. It is possible, however, to specify upper and lower limits on the blast efficiency factor, as shown in Table 3.68 for several altitudes. By using this factor, together with the ambient pressure P and the absolute temperature T at the observation point (or target) in the equations in § 3.65 (or § 3.66), an estimate can be made of the upper and lower limits of the blast parameters. An example of such an estimate will be given later.

Table 3.68

BLAST EFFICIENCY FACTORS FOR HIGH-ALTITUDE BURSTS

Burst Altitude (feet)	Blast Efficiency Factor	
	Upper Limit	Lower Limit
40,000	1.0	0.9
60,000	1.0	0.8
90,000	0.9	0.6
120,000	0.7	0.4
150,000	0.4	0.2

STANDARD CURVES AND CALCULATIONS OF BLAST WAVE PROPERTIES

3.69 In order to estimate the damage which might be expected to occur at a particular range from a given explosion, it is necessary to define the characteristics of the blast wave as they vary with time and distance. Consequently, standard "height of burst" curves of the various air blast wave properties are given here to supplement

the general discussion already presented. These curves show the variation of peak overpressure, peak dynamic pressure, arrival time, and positive phase duration with distance from ground zero for various heights of burst over a nearly ideal surface. Similar curves may also be constructed for other blast wave parameters, but the ones presented here are generally considered to be the most useful. They apply to urban targets as well as to a wide variety of other approximately ideal situations.

3.70 From the curves given below the values of the blast wave properties can be determined for a free air burst or as observed at the surface for an air burst at a particular height or for a contact surface burst (zero height). The peak overpressures, dynamic pressures, and positive phase duration times obtained in this manner are the basic data to be used in determining the blast loading and response of a target to a nuclear explosion under specified conditions. The procedures for evaluating the blast damage to be expected are discussed in Chapters IV and V.

3.71 The standard curves give the blast wave properties for a 1-kiloton TNT equivalent explosion in a sea-level atmosphere. By means of these curves and the scaling laws already presented, the corresponding properties can be calculated for an explosion of W -kilotons energy yield. Examples of the use of the curves are given on the pages facing the figures. It should be borne in mind that the data have been computed for nearly ideal conditions and that significant deviations may occur in practice.

3.72 The variation of peak overpressure with distance from a 1-kiloton TNT equivalent free air burst, i.e., a

burst in a homogeneous atmosphere where no boundaries or surfaces are present, for a standard sea-level atmosphere is shown in Fig. 3.72. This curve, together with the scaling laws and altitude corrections described above, may be used to predict incident overpressures from air bursts for those cases in which the blast wave arrives at the target without having been reflected from any surface. Other blast wave characteristics may be obtained from the Rankine-Hugoniot equations (§ 3.55 *et seq.*).

3.73 The curves in Fig. 3.73a (high-pressure range), Fig. 3.73b (intermediate-pressure range), and Fig. 3.73c (low-pressure range) show the variation with distance from ground zero of the peak overpressure at points near the ground surface for a 1-kiloton air burst as a function of the height of burst. The corresponding data for other explosion energy yields may be obtained by use of the scaling laws. The curves are applicable to a standard sea-level atmosphere and to nearly ideal surface conditions. Deviations from these conditions will affect the results, as explained in previous sections (cf. § 3.35 *et seq.*, also § 3.79 *et seq.*). It is seen from the figures, especially for overpressures of 30 pounds per square inch or less, that the curves show a pronounced "knee." Consequently, for any specified overpressure, there is a burst height that will result in a maximum surface distance from ground zero to which that overpressure extends. This is called the "optimum" height of burst for the given overpressure.

3.74 The variation of peak overpressure with distance from ground zero for an air burst at any given height can be readily derived from the curves in

Figs. 3.73a, b, and c. A horizontal line is drawn at the desired height of burst and then the ground distances for specific values of the peak overpressure can be read off. These curves differ from the one in Fig. 3.72 for a free air burst because they include the effect of reflection of the blast wave at the earth's surface. A curve for peak overpressure versus distance from ground zero for a contact surface burst can be obtained by taking the height of burst in Figs. 3.73a, b, and c to be zero.

3.75 The curves in Fig. 3.75 indicate the variation of the peak dynamic pressure along the surface with distance from ground zero and height of burst for a 1-kiloton air burst in a standard sea-level atmosphere for nearly ideal surface conditions. Since height-of-burst charts indicate conditions after the blast wave has been reflected from the surface, the curves do not represent the dynamic pressure of the incident wave. At ground zero the wind in the incident blast wave is stopped by the ground surface, and all of the incident dynamic pressure is transformed to static overpressure. Thus, the height-of-burst curves show that the dynamic pressure is zero at ground zero. At other locations, reflection of the incident blast wave produces winds that at the surface must blow parallel to the surface. The dynamic pressures associated with these winds produce horizontal forces. It is this horizontal component of the dynamic pressure that is given in Fig. 3.75.

3.76 The dependence of the positive phase duration of the overpressure and of the dynamic pressure on the distance from ground zero and on the height of burst is shown by the curves in

Fig. 3.76; the values for the dynamic pressure duration are in parentheses. As in the other cases, the results apply to a 1-kiloton explosion in a standard sea-level atmosphere for a nearly ideal surface. It will be noted, as mentioned earlier, that for a given detonation and location, the duration of the positive phase of the dynamic pressure is longer than that of the overpressure.

3.77 The curves in Figs. 3.77a and b give the time of arrival of the shock front on the ground at various distances from ground zero as a function of the height of burst for a 1-kiloton explosion under the usual conditions of a sea-level atmosphere and nearly ideal surface.

3.78 The peak overpressures in Figs. 3.74a, b, and c, which allow for reflection at the ground surface, are considered to be the side-on overpres-

ures (§ 4.06 footnote) to be used in determining target loading and response. However, further reflection is possible at the front face of a structure when it is struck by the blast wave. The magnitude of the reflected pressure $p_r(\alpha)$ depends on the side-on pressure p and the angle, α , between blast wave front and the struck surface (Fig. 3.78a). The values of the ratio $p_r(\alpha)/p$ as a function of angle of incidence for various indicated side-on pressures are given in Fig. 3.78b. It is seen that for normal incidence, i.e., when $\alpha = 0^\circ$, the ratio $p_r(\alpha)/p$ is approximately 2 at low overpressures and increases with the overpressure (§ 3.56). The curves in Fig. 3.78b are particularly applicable in the Mach region where an essentially vertical shock front moving radially strikes a reflecting surface such as the front wall of a structure (see Fig. 4.07).

(Text continued on page 124.)

The curve in Fig. 3.72 shows the variation of peak overpressure with distance for a 1 KT free air burst in a standard sea-level atmosphere.

Scaling. For targets below 5,000 feet and for burst altitudes below 40,000 feet, the range to which a given peak overpressure extends for yields other than 1 KT scales as the cube root of the yield, i.e.,

$$D = D_1 \times W^{1/3},$$

where, for a given peak overpressure, D_1 is the distance (slant range) from the explosion for 1 KT, and D is the distance from the explosion for W KT. (For higher target or burst altitudes, see § 3.64 *et seq.*)

Example

Given: A 2 MT burst at an altitude of 100,000 feet.

Find: The highest value of peak overpressure that reasonably may be expected to be incident on a target (an aircraft or missile) at an altitude of 60,000 feet.

Solution: The blast efficiency factor is based on the burst altitude, but the altitude scaling factors are based on target altitude (§ 3.64). The highest value of peak overpressure will occur with the upper limit of the blast efficiency factor.

From Table 3.68, this upper limit for a burst at an altitude of 100,000 feet is somewhat less than 0.9. Hence, the effective yield is approximately

$$\begin{aligned} 0.9W &= 0.9 \times 2 \\ &= 1.8 \text{ MT} = 1,800 \text{ KT.} \end{aligned}$$

The shortest distance from burst point to target, i.e., where the overpressure would be largest, is

$$D = 100,000 - 60,000 = 40,000 \text{ feet.}$$

From equation (3.66.2), the corresponding distance from a 1 KT burst for sea-level conditions is

$$D_1 = \frac{D}{W^{1/3}} \cdot \frac{1}{S_d}$$

From Table 3.66, S_d at the target altitude of 60,000 feet is 2.41; hence;

$$\begin{aligned} D_1 &= \frac{40,000}{(1,800)^{1/3}} \cdot \frac{1}{2.41} \\ &= 1,360 \text{ feet.} \end{aligned}$$

From Fig. 3.72, the peak overpressure at a distance of 1,360 feet from a 1 KT free air burst at sea-level conditions is 4.2 psi. The corresponding overpressure at an altitude of 60,000 feet is obtained from equation (3.66.1) and Table 3.66; thus

$$\begin{aligned} p &= p_1 S_p = 4.2 \times 0.071 \\ &= 0.30 \text{ psi.} \\ &\text{Answer} \end{aligned}$$

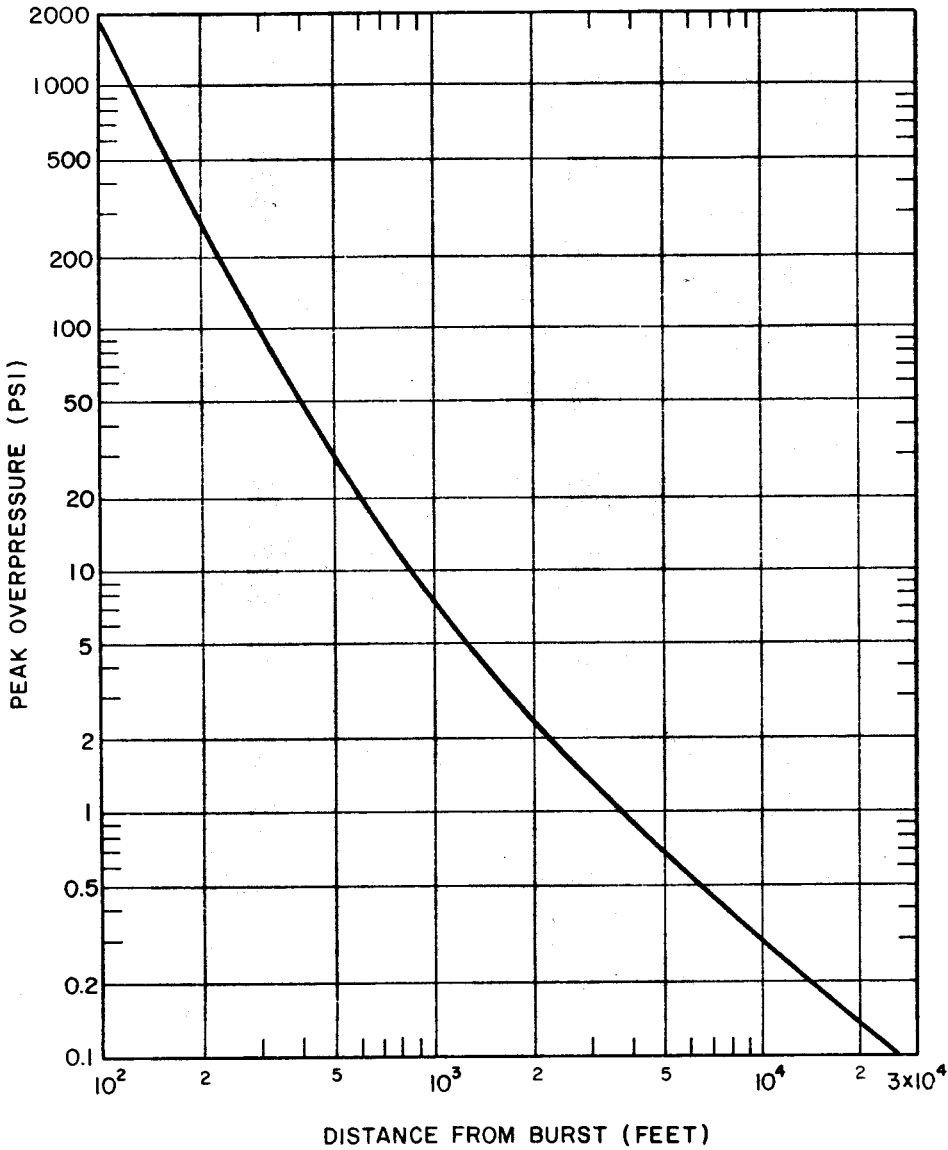

Figure 3.72. Peak overpressure from a 1-kiloton free air burst for sea-level ambient conditions.

The curves in Fig. 3.73a show peak overpressures on the ground in the high-pressure range as a function of distance from ground zero and height of burst for a 1 KT burst in a standard sea-level atmosphere. The broken line separates the regular reflection region from the Mach region and indicates where the triple point is formed (§ 3.24 *et seq.*). The data are considered appropriate to nearly ideal surface conditions. (For terrain, surface, and meteorological effects, see §§ 3.35–3.43, §§ 3.47–3.49, and § 3.79 *et seq.*)

Scaling. The height of burst and distance from ground zero to which a given overpressure extends scale as the cube root of the yield, i.e.,

$$\frac{d}{d_1} = \frac{h}{h_1} = W^{1/3},$$

where, for a given peak overpressure, d_1 and h_1 are distance from ground zero and height of burst for 1 KT, and d and h are the corresponding distance and height of burst for W KT. For a height of burst of 5,000 feet or less, a homogeneous sea-level atmosphere may be assumed.

Example

Given: An 80 KT detonation at a height of 860 feet.

Find: The distance from ground zero to which 1,000 psi overpressure extends.

Solution: The corresponding height of burst for 1 KT, i.e., the scaled height, is

$$h_1 = \frac{h}{W^{1/3}} = \frac{860}{(80)^{1/3}} = 200 \text{ feet.}$$

$$d = d_1 W^{1/3} =$$

$$110 \times (80)^{1/3} = 475 \text{ feet.}$$

Answer.

From Fig. 3.73a, an overpressure of 1,000 psi extends 110 feet from ground zero for a 200-foot burst height for a 1 KT weapon. The corresponding distance for 80 KT is

$$d = d_1 W^{1/3} =$$

$$110 \times (80)^{1/3} = 475 \text{ feet.}$$

Answer.

The procedure described above is applicable to similar problems for the curves in Figs. 3.73b and c.

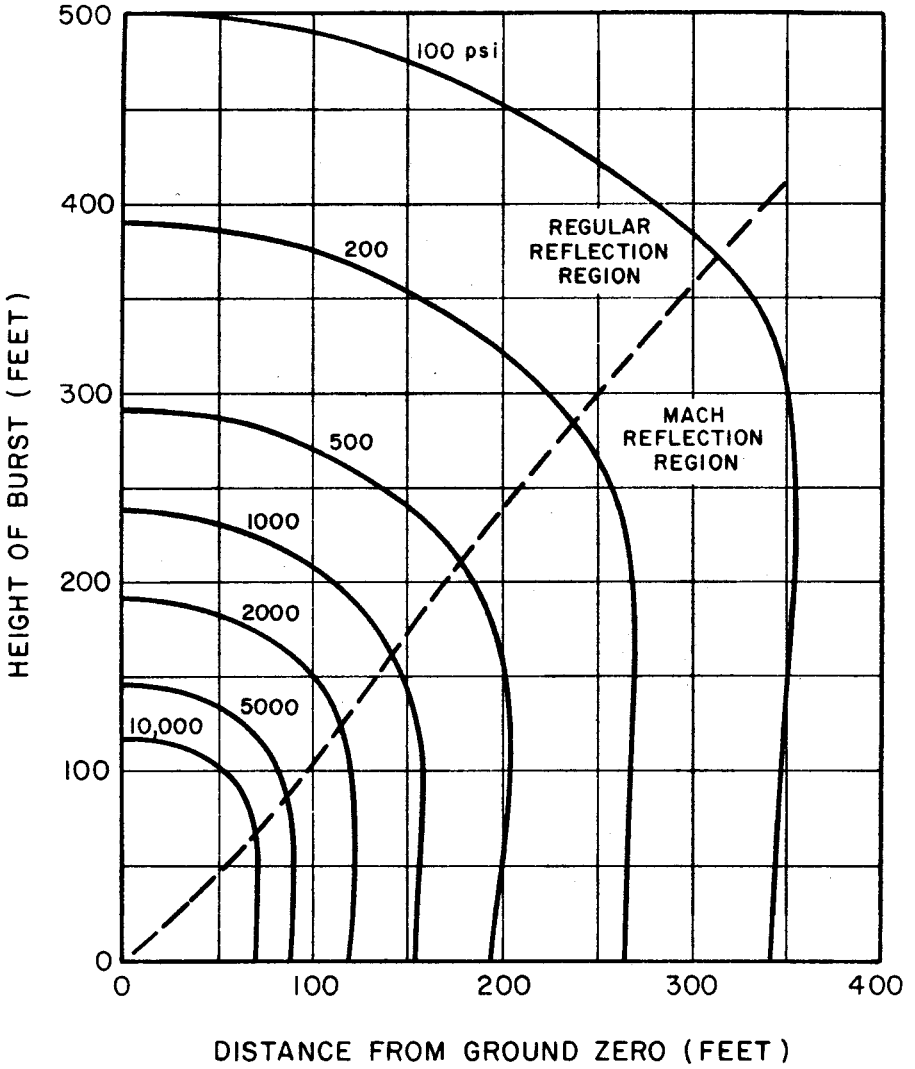

Figure 3.73a. Peak overpressures on the ground for a 1-kiloton burst (high-pressure range).

The curves in Fig. 3.73b show peak overpressures on the ground in the intermediate-pressure range as a function of distance from ground zero and height of burst for a 1 KT burst in a standard sea-level atmosphere. The broken line separates the regular reflection region from the Mach region and indicates where the triple point is formed (§ 3.24 *et seq.*). The data are considered appropriate for nearly ideal surface conditions. (For terrain, surface, and meteorological effects, see (§ 3.35–3.43, § 3.47–3.49, and § 3.79 *et seq.*).

Scaling. The height of burst and the distance from ground zero to which a given peak overpressure extends scale as the cube root of the yield, i.e.,

$$\frac{d}{d_1} = \frac{h}{h_1} = W^{1/3},$$

where, for a given peak overpressure, d_1 and h_1 are distance from ground zero and height of burst for 1 KT, and d and h are the corresponding distance and height of burst for W KT. For a height of burst of 5,000 feet or less, a homogeneous sea-level atmosphere may be assumed.

Example

Given: A 100 KT detonation at a height of 2,320 feet.

Find: The peak overpressure at 1,860 feet from ground zero.

Solution: The corresponding height of burst for 1 KT is

$$h_1 = \frac{h}{W^{1/3}} = \frac{2,320}{(100)^{1/3}} = 500 \text{ feet.}$$

and the ground distance is

$$d_1 = \frac{d}{W^{1/3}} = \frac{1,860}{(100)^{1/3}} = 400 \text{ feet.}$$

From Fig. 3.73b, at a ground distance of 400 feet and a burst height of 500 feet, the peak overpressure is 50 psi. *Answer.*

The procedure described above is applicable to similar problems for the curves in Figs. 3.73a and c.

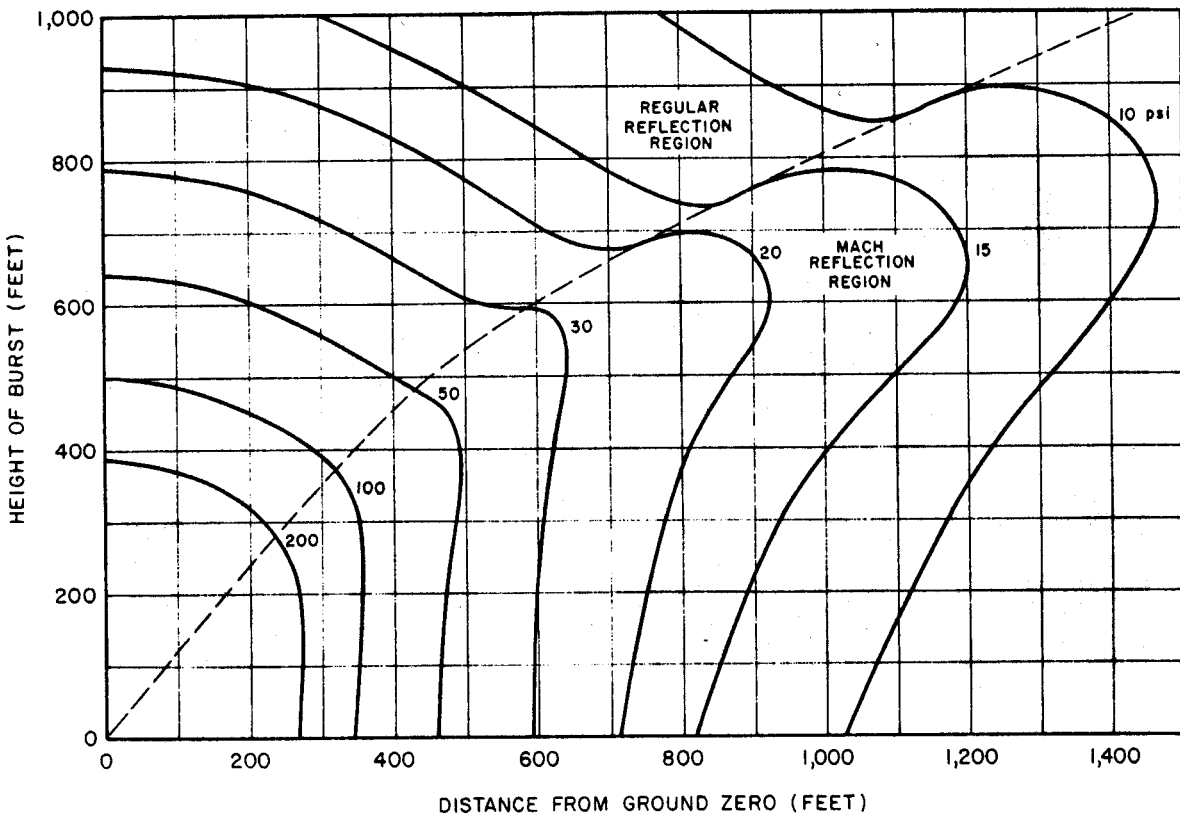

Figure 3.73b. Peak overpressures on the ground for a 1-kiloton burst (intermediate-pressure range).

The curves in Fig. 3.73c show peak overpressures on the ground in the low-pressure range as a function of distance from ground zero and height of burst for a 1 KT burst in a standard sea-level atmosphere. The broken line separates the regular reflection region from the Mach region and indicates where the triple point is formed (§ 3.24 *et seq.*). The data are considered appropriate for nearly ideal surface conditions. (For terrain, surface, and meteorological effects, see §§ 3.35–3.43, §§ 3.47–3.49, and § 3.79 *et seq.*)

Scaling. The height of burst and the distance from ground zero to which a given peak overpressure extends scale as the cube root of the yield, i.e.,

$$\frac{d}{d_1} = \frac{h}{h_1} = W^{1/3},$$

where, for a given peak overpressure, d_1 and h_1 are the distance from ground zero and height of burst for 1 KT, and d and h are the corresponding distance and height of burst for W KT. For a height of burst of 5,000 feet or less, a homogeneous sea-level atmosphere may be assumed.

Example

Given: A 125 KT detonation.

Find: The maximum distance from ground zero to which 4 psi extends, and the height of burst at which 4 psi extends to this distance.

Solution: From Fig. 3.73c, the maximum ground distance to which 4 psi extends for a 1 KT weapon is 2,600 feet. This occurs for a burst height of approximately 1,100 feet. Hence, for a 125 KT detonation, the required burst height is

$$\begin{aligned} h &= h_1 W^{1/3} = 1,100 \times (125)^{1/3} \\ &= 5,500 \text{ feet.} \end{aligned}$$

This is sufficiently close to 5,000 feet for a homogeneous atmosphere to be assumed. The distance from ground zero is then

$$\begin{aligned} d &= d_1 W^{1/3} = 2,600 \times (125)^{1/3} \\ &= 13,000 \text{ feet.} \quad \text{Answer.} \end{aligned}$$

The procedure described above is applicable to similar problems for the curves in Figs. 3.73a and b.

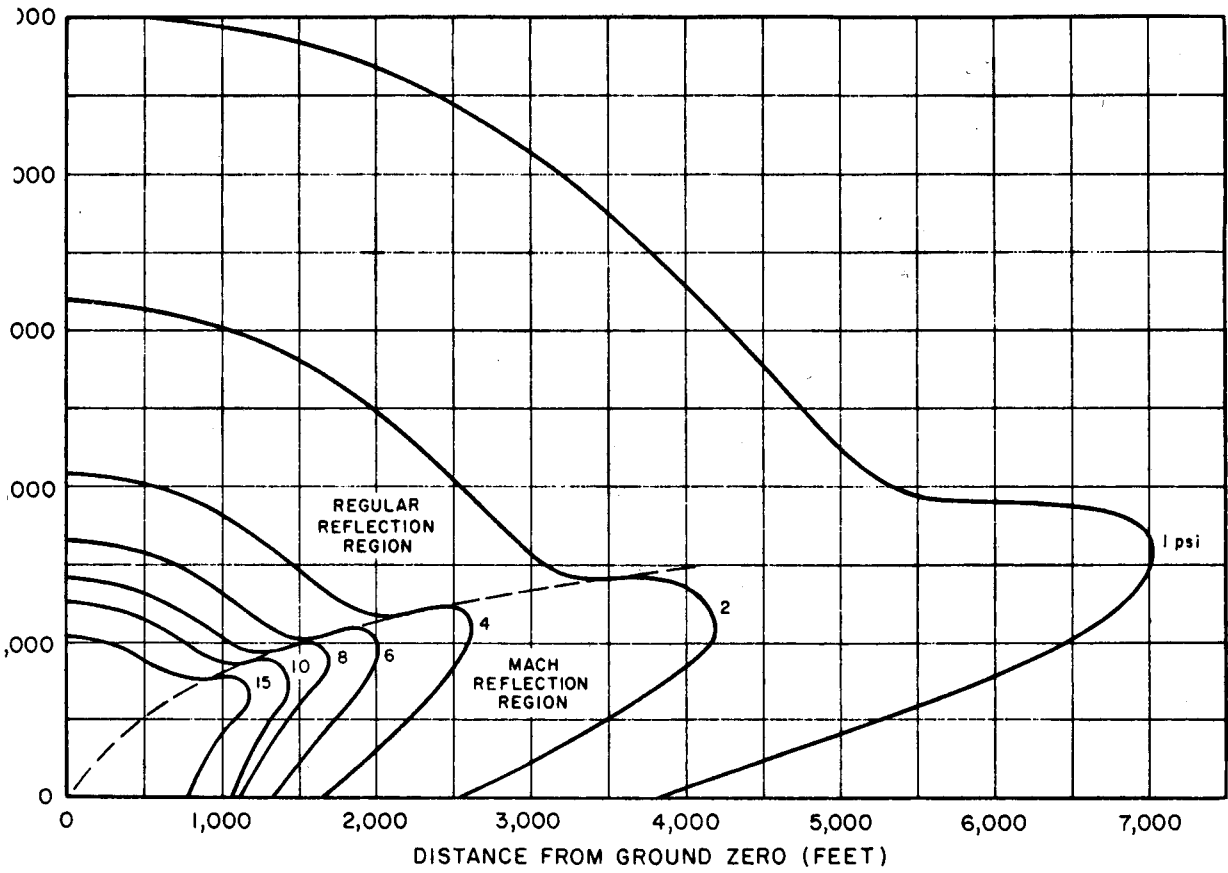

Figure 3.73c. Peak overpressures on the ground for 1-kiloton burst (low-pressure range).

The curves in Fig. 3.75 show the horizontal component of peak dynamic pressure on the ground as a function of distance from ground zero and height of burst for a 1 KT burst in a standard sea-level atmosphere. The data are considered appropriate for nearly ideal surface conditions. (For terrain, surface, and meteorological effects, see §§ 3.35–3.43, §§ 3.47–3.49, and § 3.79 *et seq.*)

Scaling. The height of burst and distance from ground zero to which a given peak dynamic pressure value extends scale as the cube root of the yield, i.e.,

$$\frac{d}{d_1} = \frac{h}{h_1} = W^{1/3},$$

where, for a given peak dynamic pressure, h_1 and d_1 are the height of burst and distance from ground zero for 1 KT, and h and d are the corresponding height of burst and distance for W KT. For a height of burst of 5,000 feet or less, a homogeneous sea-level atmosphere may be assumed.

Example

Given: A 160 KT burst at a height of 3,000 feet.

Find: The horizontal component of peak dynamic pressure on the surface at 6,000 feet from ground zero.

Solution: The corresponding height of burst for 1 KT is

$$h_1 = \frac{h}{W^{1/3}} = \frac{3,000}{(160)^{1/3}} = 550 \text{ feet.}$$

The corresponding distance for 1 KT is

$$d_1 = \frac{d}{W^{1/3}} = \frac{6,000}{(160)^{1/3}} = 1,110 \text{ feet.}$$

From Fig. 3.75, at a distance of 1,110 feet from ground zero and a burst height of 550 feet, the horizontal component of the peak dynamic pressure is approximately 3 psi. *Answer.*

Calculations similar to those described in connection with Figs. 3.74a and c may be made for the horizontal component of the peak dynamic pressure (instead of the peak overpressure) by using Fig. 3.75.

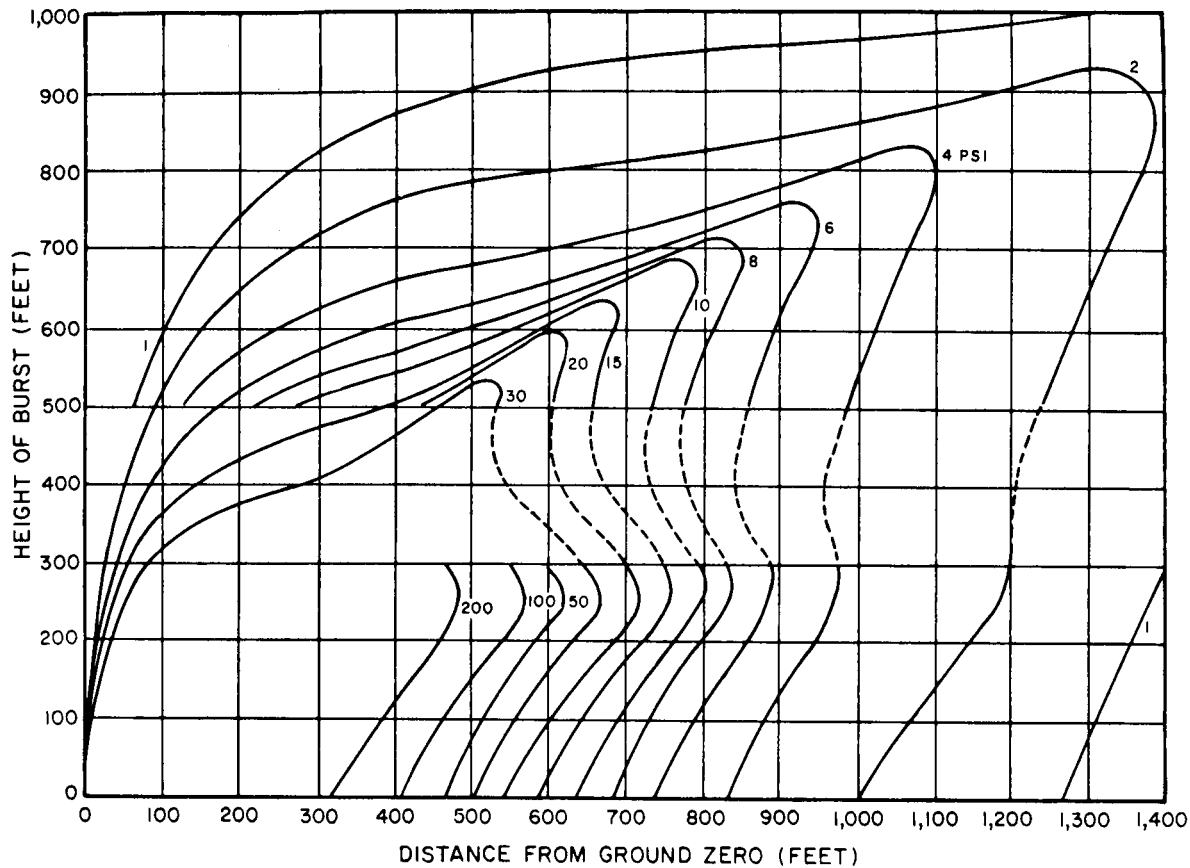

Figure 3.75. Horizontal component of peak dynamic pressure for 1-kiloton burst.

The curves in Fig. 3.76 show the duration on the ground of the positive phase of the overpressure and of the dynamic pressure (in parentheses) as a function of distance from ground zero and height of burst for a 1 KT burst in a standard sea-level atmosphere. The curves are considered appropriate for nearly ideal surface conditions.

Scaling. The required relationships are

$$\frac{d}{d_1} = \frac{h}{h_1} = \frac{t}{t_1} = W^{1/3},$$

where d_1 , h_1 , and t_1 are the distance from ground zero, the height of burst, and duration, respectively, for 1 KT; and d , h , and t are the corresponding distance, height of burst, and duration for W KT. For a height of burst of 5,000 feet or less, a homogeneous sea-level atmosphere may be assumed.

Example

Given: A 160 KT explosion at a height of 3,000 feet.

Find: The positive phase duration on the ground of (a) the overpressure, (b) the dynamic pressure at 4,000 feet from ground zero.

Solution: The corresponding height of burst for 1 KT is

$$h_1 = \frac{h}{W^{1/3}} = \frac{3,000}{(160)^{1/3}} = 550 \text{ feet,}$$

and the corresponding distance from ground zero is

$$d_1 = \frac{d}{W^{1/3}} = \frac{4,000}{(160)^{1/3}} = 740 \text{ feet.}$$

(a) From Fig. 3.76, the positive phase duration of the overpressure for a 1 KT at 740 feet from ground zero and a burst height of 550 feet is 0.18 second. The corresponding duration of the overpressure positive phase for 160 KT is, therefore,

$$t = t_1 W^{1/3} = 0.18 \times (160)^{1/3} = 1.0 \text{ second. Answer.}$$

(b) From Fig. 3.76, the positive phase duration of the dynamic pressure for 1 KT at 740 feet from ground zero and a burst height of 550 feet is 0.34 second. The corresponding duration of the dynamic pressure positive phase for 160 KT is, therefore,

$$t = t_1 W^{1/3} = 0.34 \times (160)^{1/3} = 1.8 \text{ second. Answer.}$$

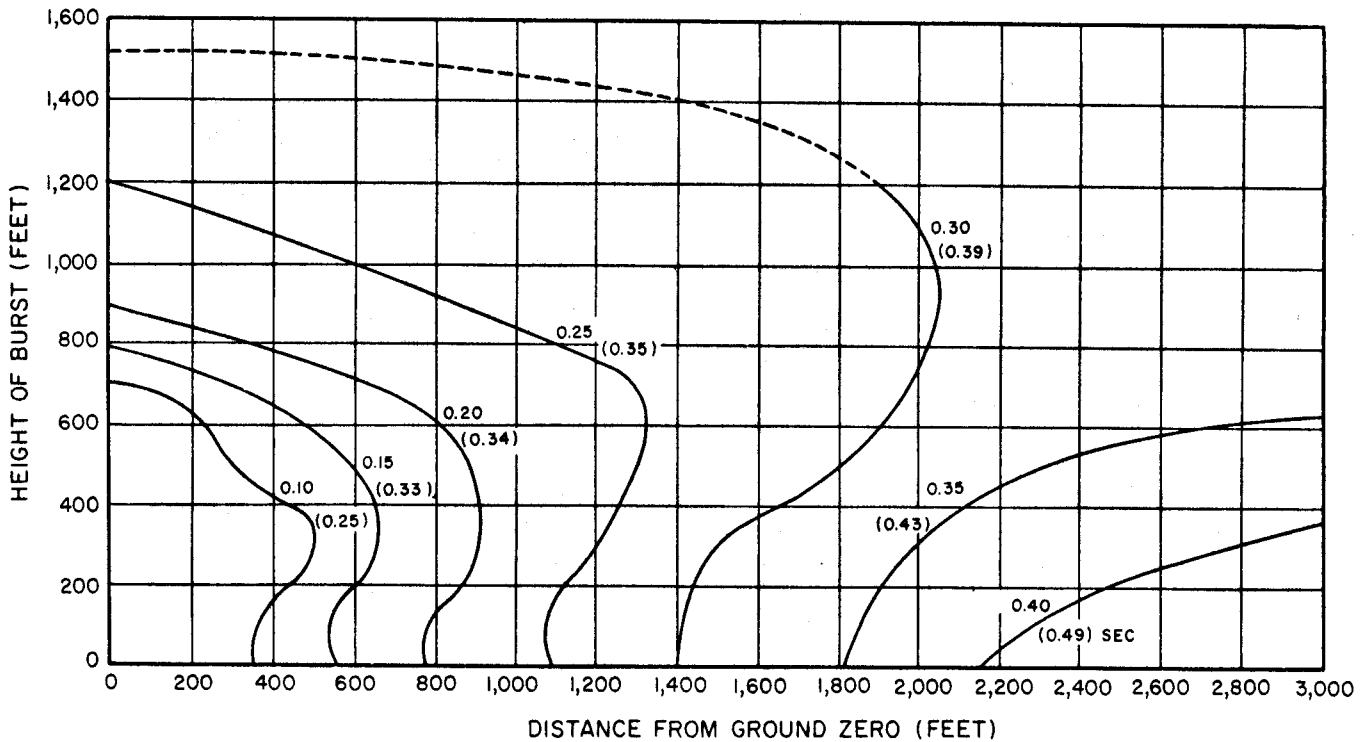

Figure 3.76. Positive phase duration on the ground of overpressure and dynamic pressure (in parentheses) for 1-kiloton burst.

The curves in Figs. 3.77a and b give the time of arrival in seconds of the blast wave on the ground as a function of distance from ground zero and height of burst for a 1 KT burst in a standard sea-level atmosphere. The curves are considered appropriate for nearly ideal surface conditions.

Scaling. The required relationships are

$$\frac{d}{d_1} = \frac{h}{h_1} = \frac{t}{t_1} = W^{1/3},$$

where d_1 , h_1 , and t_1 are the distance from ground zero, height of burst, and time of arrival, respectively, for 1 KT; and d , h , and t are the corresponding distance, height of burst, and time for W KT. For a height of burst of 5,000 feet or less, a homogeneous sea-level atmosphere may be assumed.

Example

Given: A 1 MT explosion at a height of 5,000 feet.

Find: The time of arrival of the blast wave at a distance of 10 miles from ground zero.

Solution: The corresponding burst height for 1 KT is

$$h_1 = \frac{h}{W^{1/3}} = \frac{5,000}{(1,000)^{1/3}} = 500 \text{ feet.}$$

The corresponding distance from ground zero for 1 KT is

$$d_1 = \frac{D}{W^{1/3}} = \frac{5,280 \times 10}{(1,000)^{1/3}} = 5,280 \text{ feet.}$$

From Fig. 3.77b, at a height of burst of 500 feet and a distance of 5,280 feet from ground zero, the arrival time is 4.0 seconds for 1 KT. The corresponding arrival time for 1 MT is

$$t = t_1 W^{1/3} = 4.0 \times (1,000)^{1/3} = 40 \text{ seconds. } \textit{Answer.}$$

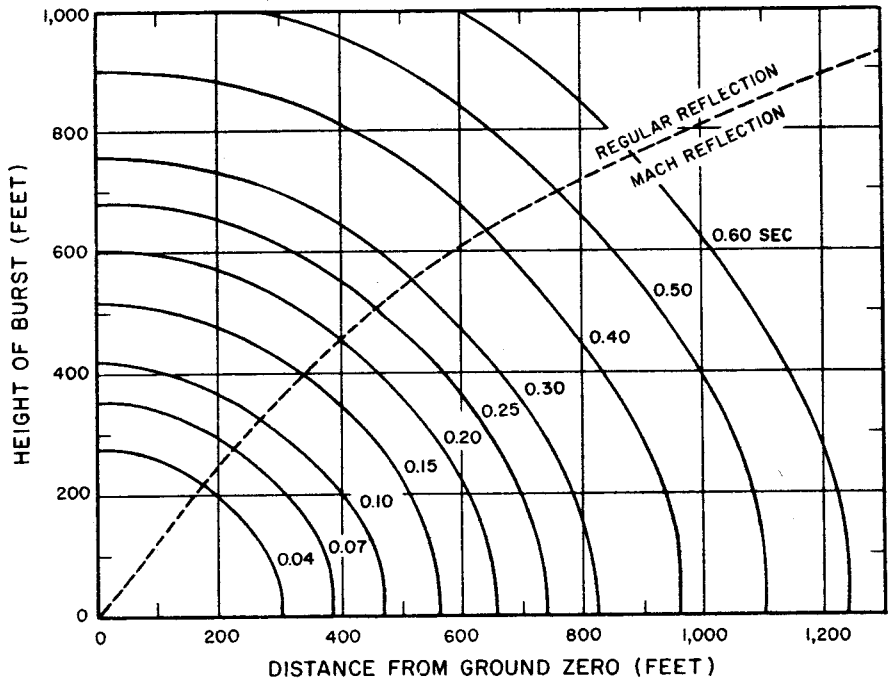

Figure 3.77a. Arrival times on the ground of blast wave for 1-kiloton burst (early times).

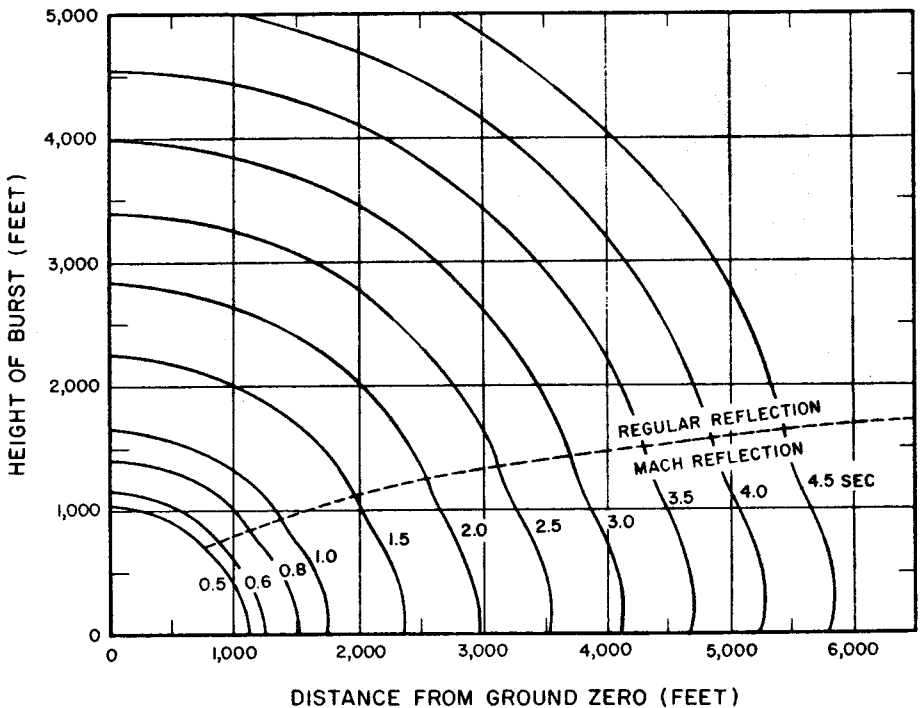

Figure 3.77b. Arrival times on the ground of blast wave for 1-kiloton burst (late times)

The reflected overpressure ratio $p_{r(\alpha)}/p$ is plotted in Fig. 3.78b as a function of the angle of incidence of the blast wave front for various values of the peak (side-on) overpressure. The curves apply to a wave front striking a reflecting surface, such as a wall of a structure.

$p_{r(\alpha)}$ = reflected blast wave overpressure for any given angle of incidence (psi).

p = initial peak incident overpressure (psi).

α = angle between the blast wave front and the reflecting surface (degrees).

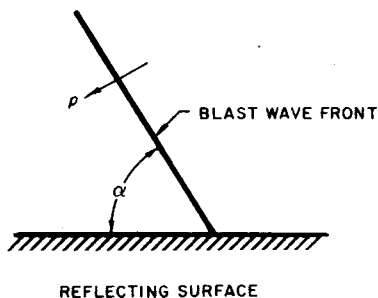

Figure 3.78a. Angle of incidence (α) of blast wave front with reflecting surface.

Example

Given: A shock wave of 50 psi initial peak overpressure striking a surface at an angle of 35° .

Find: The reflected shock wave overpressure.

Solution: From Fig. 3.78b, the reflected overpressure ratio, $p_{r(\alpha)}/p$, for 50 psi and an angle of incidence of 35° is 3.6; hence,

$$p_{r(35^\circ)} = 3.6p = 3.6 \times 50 \\ = 180 \text{ psi. Answer.}$$

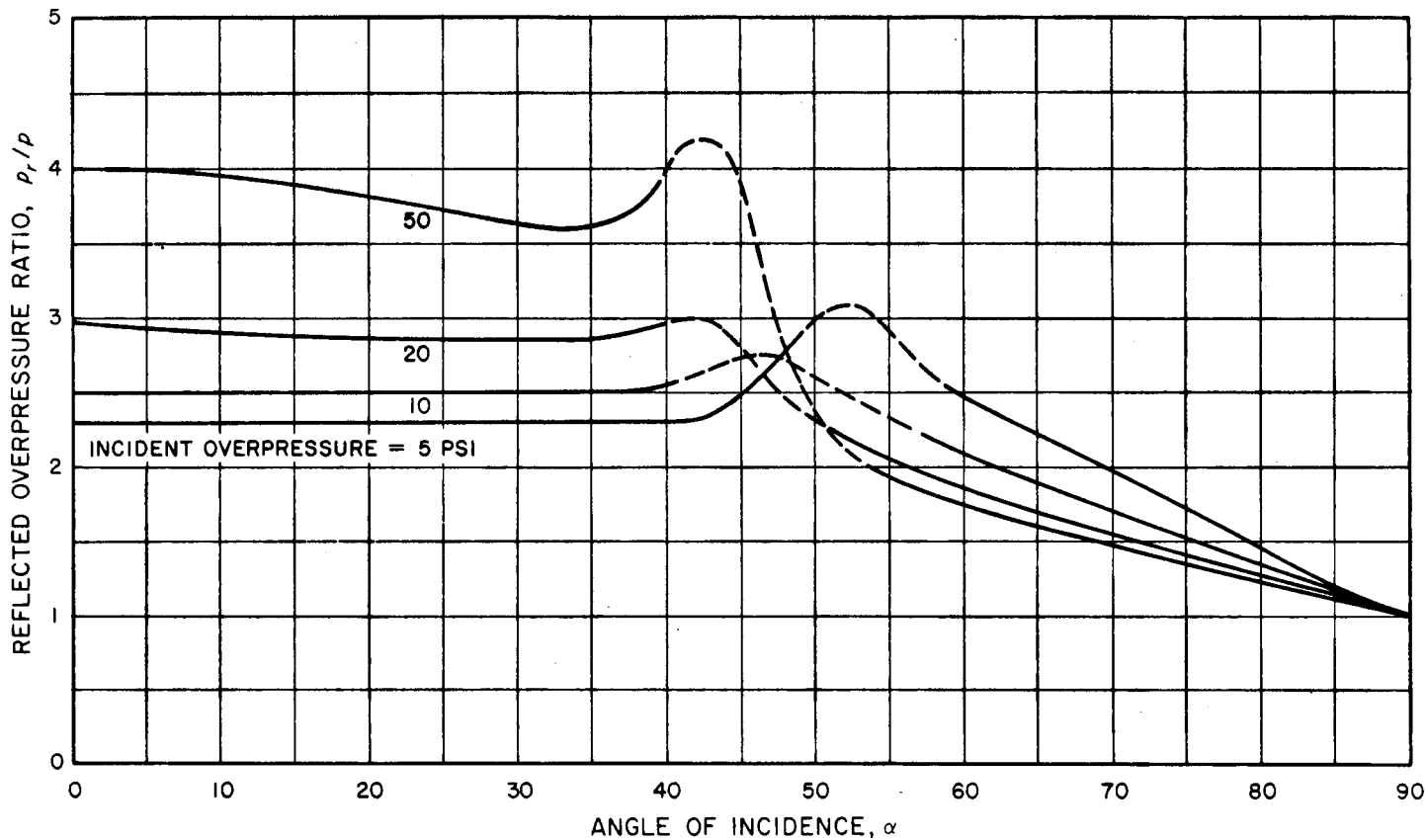

Figure 3.78b. Reflected overpressure ratio as a function of angle of incidence for various side-on overpressures.

(Text continued from page 107.)

THE PRECURSOR

3.79 The foregoing results have referred to blast wave conditions near the surfaces that are ideal or nearly ideal (§ 3.47), so that the Rankine-Hugoniot equations are applicable. When the surface is nonideal, there may be mechanical or thermal effects (or both) on the blast wave. Some of the phenomena associated with mechanical effects were mentioned in § 3.48. As a consequence of thermal nonideal behavior, the overpressure and dynamic pressure patterns can be distorted. Severe thermal effects are associated with the formation of a precursor (§ 3.49) which produces significant changes in the parameters of the blast wave.

3.80 When a nuclear weapon is detonated over a thermally nonideal (heat-absorbing) surface, radiation from the fireball produces a hot layer of air, referred to as a "thermal layer," near the surface. This layer, which often includes smoke, dust, and other particulate matter, forms before the arrival of the blast wave from an air burst. It is thus referred to as the preshock thermal layer. Interaction of the blast wave with the hot air layer may affect the reflection process to a considerable extent. For appropriate combinations of explosion energy yield, burst height, and heat-absorbing surfaces, an auxiliary (or secondary) blast wave, the precursor, will form and will move ahead of the main incident wave for some distance. It is called precursor because it precedes the main blast wave.

3.81 After the precursor forms, the main shock front usually no longer ex-

tends to the ground; if it does, the lower portion is so weakened and distorted that it is not easily recognized. Between the ground and the bottom edge of the main shock wave is a gap, probably not sharply defined, through which the energy that feeds the precursor may flow. Ahead of the main shock front, the blast energy in the precursor is free not only to follow the rapidly moving shock front in the thermal layer, but also to propagate upward into the undisturbed air ahead of the main shock front. This diverging flow pattern within the precursor tends to weaken it, while the energy which is continually fed into the precursor from the main blast wave tends to strengthen the precursor shock front. The foregoing description of what happens within a precursor explains some of the characteristics shown in Fig. 3.81. Only that portion of the precursor shock front that is in the preshock thermal layer travels faster than the main shock front; the energy diverging upward, out of this layer, causes the upper portion to lose some of its forward speed. The interaction of the precursor and the main shock front indicates that the main shock is continually overtaking this upward-traveling energy. Dust, which may billow to heights of more than 100 feet, shows the upward flow of air in the precursor.

3.82 Considerable modification of the usual blast wave characteristics may occur within the precursor region. The overpressure wave form shows a rounded leading edge and a slow rise to its peak amplitude. In highly disturbed waveforms, the pressure jump at the leading edge may be completely absent. (An example of a measured overpressure waveform in the precursor region is

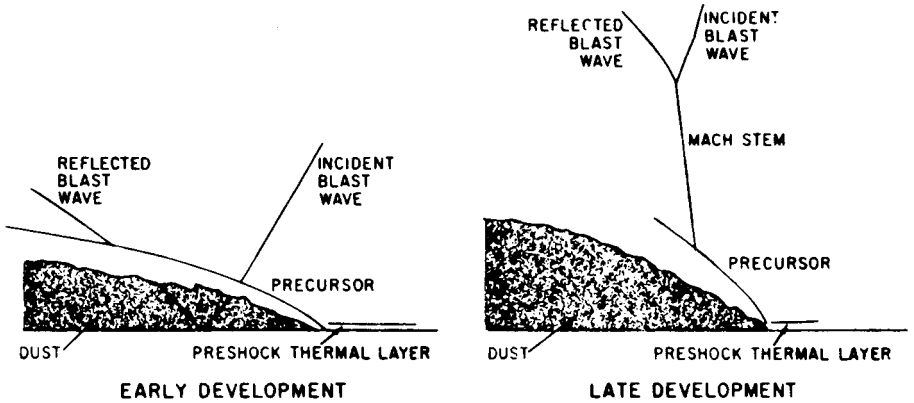

Figure 3.81. Precursor characteristics.

given in Fig. 4.67a.) Dynamic pressure waveforms often have high-frequency oscillations that indicate severe turbulence. Peak amplitudes of the precursor waveforms show that the overpressure has a lower peak value and the dynamic pressure a higher peak value than over a surface that did not permit a precursor to form. The higher peak value of the dynamic pressure is primarily attributable to the increased density of the moving medium as a result of the dust loading in the air. Furthermore, the normal Rankine-Hugoniot relations at the shock front no longer apply.

3.83 Examples of surfaces which are considered thermally nearly ideal (unlikely to produce significant precursor effects) and thermally nonideal (expected to produce a precursor for suitable combinations of burst height and ground distance) are given in Table 3.83. Under many conditions, e.g., for scaled heights of burst in excess of 800 feet or at large ground distances (where the peak overpressure is less than about 6 psi), precursors are not expected to occur regardless of yield and type of

surface. Thermal effects on the blast wave are also expected to be small for contact surface bursts; consequently, it is believed that in many situations, especially in urban areas, nearly ideal blast wave conditions would prevail.

3.84 For this reason, the curves for various air blast parameters presented earlier, which apply to nearly ideal surface conditions, are considered to be

Table 3.83

EXAMPLES OF THERMALLY NEARLY IDEAL AND THERMALLY NONIDEAL SURFACES

Thermally Nearly Ideal (precursor unlikely)	Thermally Nonideal (precursor may occur for low air bursts)
Water	Desert sand
Ground covered by white smoke	Coral
Heat-reflecting concrete	Asphalt
Ice	Surface with thick low vegetation
Packed snow	Surface covered by dark smoke
Moist soil with sparse vegetation	Most agricultural areas
Commercial and industrial areas	Dry soil with sparse vegetation

most representative for general use. It should be noted, however, that blast phenomena and damage observed in the precursor region for low air bursts at the Nevada Test Site may have resulted from nonideal behavior of the surface. Under such conditions, the overpressure waveform may be irregular and may show a slow rise to a peak value somewhat less than that expected for nearly ideal conditions (§ 3.82). Consequently, the peak value of reflected pressure on the front face of an object struck by the blast wave may not exceed the peak value of the incident pressure by more than a factor of two instead of

the much higher theoretical factor for an ideal shock front as given by equation (3.56.2).

3.85 Similarly, the dynamic pressure waveform will probably be irregular (§ 3.82), but the peak value may be several times that computed from the peak overpressure by the Rankine-Hugoniot relations. Damage to and displacement of targets which are affected by dynamic pressure may thus be considerably greater in the nonideal precursor region for a given value of peak overpressure than under nearly ideal conditions.

BIBLIOGRAPHY

- *BANISTER, J. R., and L. J. VORTMAN, "Effects of a Precursor Shock Wave on Blast Loading of a Structure," Sandia Corporation, Albuquerque, New Mexico, October 1960, WT-1472.
- *BETHE, H. A., *et al.*, "Blast Wave," University of California, Los Alamos Scientific Laboratory, March 1958, LA-2000.
- BRINKLEY, S. R., JR., and J. G. KIRKWOOD, "Theory of the Propagation of Shock Waves," *Phys. Rev.*, **71**, 606 (1947); **72**, 1109 (1947).
- BRODE, H. L., "Numerical Solution of Spherical Blast Waves," *J. Appl. Phys.* **26**, 766 (1955).
- BRODE, H. L., "Review of Nuclear Weapons Effects," *Ann. Rev. Nuclear Science*, **18**, 153 (1968).
- BRODE, H. L., "Height of Burst Effects at High Overpressures," Rand Corporation, Santa Monica, California, July 1970, RM-6301-DASA, DASA 2506.
- COURANT, R., and K. O. FRIEDRICHS, "Supersonic Flow and Shock Waves," Interscience Publishers, Inc., 1948.
- GOLDSTINE, H. H., and J. VON NEUMANN, "Blast Wave Calculations," *Comm. on Pure and Appl. Math.* **8**, 327 (1955).
- LETHO, D. L. and R. A. LARSON, "Long Range Propagation of Spherical Shockwaves from Explosions in Air," U.S. Naval Ordnance Laboratory, July 1969, NOLTR 69-88.
- LIEPMANN, H. W., and A. E. PUCKETT, "Aerodynamics of a Compressible Fluid," John Wiley and Sons, Inc., 1947.
- PENNEY, W. G., D. E. J. SAMUELS, and G. C. SCORGIE, "The Nuclear Explosive Yields at Hiroshima and Nagasaki," *Phil. Trans. Roy. Soc., A* **266**, 357 (1970).
- REED, J. W., "Airblast from Plowshare Projects," in Proceedings for the Symposium on Public Health Aspects of Peaceful Uses of Nuclear Explosives, Southwestern Radiological Health Laboratory, April 1969, SWRHL-82, p. 309.
- TAYLOR, G. I., "The Formation of a Blast Wave by a Very Intense Explosion," *Proc. Roy. Soc.*, **A 201**, 159, 175 (1950).
- *U.S. Standard Atmosphere, U.S. Government Printing Office, Washington, D.C., 1962, Supplements, 1966.

*These documents may be purchased from the National Technical Information Service, U.S. Department of Commerce, Arlington, Virginia 22161.